



CTS CPVC Technical

CTS CPVC Technical Information, Design & Installation Guide

CTS CPVC Technical Information, Design & Installation Guide



ENGINEERING GUIDE

Contact Spears® for any information not found.



Certified Safe Alternative to Metal Plumbing Systems



All conventional metal plumbing systems corrode leaving their corrosive wastes for deposit into the water system. CPVC thermoplastic system components never corrode. Spears® EverTUFF® CTS CPVC system of fittings, pipe, supply stops, valves & solvent cement are Certified lead-free by NSF® International (NSF®) in accordance with ANSI/NSF® 61 and NSF® 372 for compliance with all State & Federal Regulations. Approved by national, state and most municipal building codes* and listed by ICC to ASTM E84 for Flame & Smoke Characteristics of less than 25/50 for use in return air plenums (See PMG Listing No. PMG-1278 at www.icc-es-pmg.org). Spears® CTS CPVC products are ideally suited for hot and cold water distribution systems in residential and commercial structures, as well as recreational vehicles, modular homes and mobile homes.

*Check state and local codes.

Full Line of CTS CPVC Solvent Cement, Fittings, Pipe, Supply Stops & Ball Valves 1/2" Through 2" Plus Supplemental IPS CPVC in 2-1/2" & Up

EverTUFF® CPVC pipe and fittings are available for most any size project using Copper-Tube-Size (CTS) CPVC in sizes 1/2" through 2". Plus, can be used with supplemental Schedule 40 and Schedule 80 CPVC Iron Pipe Size (IPS) for sizes 2-1/2" and larger. Available for use in multi-story installations where adequate design and installation practices have been utilized.

Exceptional Corrosion Resistance

Unlike metal systems, CPVC CTS products never rust, scale, or pit, and will provide many years of maintenance-free service and extended system life.

Energy Savings

Low heat conductivity minimizes heat loss in hot water systems.

Higher Flow Capacity

Smooth interior walls result in lower pressure loss and higher volume than conventional metal systems.

Lower System Costs

Lower material costs than metallic systems, combined with lighter weight and ease of installation, can substantially reduce installation cost.

Suitable for Commercial Hot Water

CTS CPVC products can handle fluids at service temperatures up to 180°F (82°C).

CTS CPVC 1/4-Turn Angle Supply Stop



Used with plumbing fixtures to terminate and control hot and cold water supply, Angle Supply Stops NSF® Certified to ASTM F 1970 for use in ASTM D 2846 Hot & Cold Water Distribution Systems. All Supply Stops are rated to 100 psi @ 180°F. Available in 1/2" CTS Socket, Spears® patented Special Reinforced (SR) and 1/2" FIPT female thread inlets. Choose 1/2" and 3/8" NPT male thread outlets or 1/2" and 3/8" Compression male thread outlets for connection to conventional Female NPT or Female Compression faucet or toilet supply lines with captive seals.

CTS CPVC Ball Valves

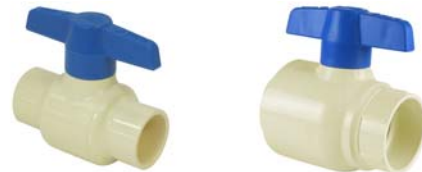

Residential

Commercial

Spears® EverTUFF® Copper-Tube-Size Ball Valves feature a one-piece design that never requires adjustment. EPDM O-ring seal and PTFE Seats enable bubble-tight shut off. Choose Heavy Commercial design manufactured to ASTM F1970 for use in ASTM D 2846 Hot & Cold Water Distribution Systems or Economical Residential design. Rated to 100 psi maximum internal pressure at 180°F and NSF® Certified Lead-Free for use in potable water systems.

Progressive Products From Spears® Innovation & Technology



CTS CPVC Technical CTS Fittings & Valves Overview

Spears® EverTUFF® Exclusive Specialty Fittings - All Lead-Free...

CTS CPVC Caps & Couplings



- Uses **NO Solvent Cement**
- Permanent Connection
- Excellent for Repairs & Transition to Copper Systems
- NSF® Certified Lead-Free

Patented Special Reinforced (SR) Plastic Threaded Transition Fittings



- Eliminates Split Threads
- Eliminates Leaks Associated with Over Tightening
- Eliminates MIC, Electrolytic & Soil Chemistry Corrosion
- NSF® Certified Lead-Free

Gasket Sealed Brass-Threaded Transition Fittings



- Eliminates Radial Stress
- Requires NO Thread Sealants
- Eliminates Sealant Incompatibility
- NSF® Certified Lead-Free

Stainless Steel Threaded Transition Fittings



- Excellent for Transitions to Metal Systems
- NSF® Certified Lead-Free

Lead-Free Brass Compression Unions



- NSF® Certified Lead-Free
- Transitions to Copper Tubing and Other Metal Systems

Spears® EverTUFF®, The Full-Service CTS CPVC Product Line...

Application

Spears® EverTUFF® Copper-Tube-Size (CTS) products are manufactured from chlorinated polyvinyl chloride (CPVC) for use with SDR-11 piping systems of CTS outside diameter in hot and cold water distribution systems in nominal pipe sizes 1/2" through 2". CTS CPVC products can be used in conjunction with Spears® supplemental Schedule 40 and Schedule 80 CPVC Iron-Pipe-Size (IPS) pipe and fittings for sizes 2-1/2" through 12" in commercial multi-story installations. Check state and local codes for application and restrictions.

Working Pressure

Spears® EverTUFF® CTS CPVC fittings, pipe and valves have a continuous working pressure rating of 100 psi at 180°F, unless designated for cold water use only.

Conformance Standards

Spears® EverTUFF® CTS CPVC fittings, pipe, valves and solvent cement conforms to ASTM D 2846 Specification for Chlorinated Poly (Vinyl Chloride) (CPVC) Plastic Hot and Cold Water Distribution Systems. Solvent Cement meets ASTM F 493.

Product Certification

Spears® EverTUFF® CTS CPVC piping systems are certified by NSF® International (NSF®) to ASTM D 2846 for use in Hot and Cold Water Distribution Systems, to the Uniform Plumbing Code (NSF® U.P.Code) and for use in potable water service. All Spears® EverTUFF® CTS CPVC products are NSF® certified lead-free in accordance with ANSI/NSF® Standard 61 and 372 for compliance with all State & Federal regulation. All Spears® EverTUFF® CTS CPVC pipe and fittings are Listed by ICC to ASTM E84 for flame spread/smoke development of less than 25/50.

Sample Engineering Specifications

All fittings, pipe, supply stops and valves shall be EverTUFF® Copper-Tube- Size (CTS) constructed from CPVC 4120 with minimum Cell Classification of 23447. All CTS CPVC products shall be produced to applicable requirements of ASTM D 2846 and rated to 100 psi at 180°F, unless specifically designated for cold water service only. Solvent cement shall be produced to applicable requirements of ASTM D 2846 and ASTM F 493. All supply stops shall be 1/4 turn angle or straight pattern CTS CPVC with NPT or Compression male thread outlets. All ball valves shall be CTS CPVC sealed unit type with EPDM O-ring and double stop Polypropylene handle in either Commercial or Residential design. All CTS CPVC products shall be certified lead-free for potable water use by NSF® International in accordance with NSF® 61 and NSF® 372. All pipe and fittings shall be Listed by ICC for compliance with ASTM E84 Surface Burning Characteristic with flame spread/smoke development of less than 25/50 for use in return air plenums, as manufactured by Spears® Manufacturing Company.



The information contained in this publication is based on current information and product design at the time of publication and is subject to change without notification. Our ongoing commitment to product improvement may result in some variation. No representations, guarantees or warranties of any kind are made as to its accuracy, suitability for particular applications or results to be obtained therefrom. For verification of technical data or additional information not contained herein, please contact Spears® Technical Services Department [West Coast: (818) 364-1611 - East Coast: (678) 985-1263].

PURPOSE OF THIS MANUAL

This manual is intended for use by specifiers, installers, and users in the selection, design, installation, and inspection of CPVC Hot & Cold Water Distribution systems installed using Spears® EverTUFF® CTS & CPVC Iron Pipe Size (IPS) products. All information contained within this manual is considered vital to obtain proper system performance and must be read and fully understood before attempting to install these products. If you have any questions about the safe and proper installation of these products, contact Spears® Manufacturing Company, 15853 Olden Street, Sylmar CA 91342 USA, Telephone, (818) 364-1611 • (800) 862-1499.

Application

Spears® EverTUFF® Copper Tube Size (CTS) Pipe and Fittings are manufactured from chlorinated polyvinyl chloride (CPVC) for use with SDR 11 piping systems of CTS outside diameter in hot and cold water distribution systems. Supplemental EverTUFF® Industrial Iron Pipe Size (IPS) CPVC pipe and fittings are manufactured for use where larger diameter (2-1/2" & larger) systems are required, such as multi-story buildings. Check state and local codes for application and restrictions.

Conformance Standards

Spears® EverTUFF® CTS CPVC Pipe and Fittings conform to ASTM D 2846 Specification for Chlorinated Poly (Vinyl Chloride) (CPVC) Plastic Hot and Cold Water Distribution Systems. Supplemental EverTUFF® Industrial Iron Pipe Size (IPS) CPVC for use where larger diameter (2-1/2" & larger) systems are required. Conform to ASTM F 439, specification for Chlorinated Poly (Vinyl Chloride) (CPVC) Plastic Pipe Fittings, Schedule 80; and ASTM F441, Specification for Chlorinated Poly (Vinyl Chloride) (CPVC) Plastic Pipe, Schedules 40 and 80. All CTS & Iron Pipe Size (IPS) valves are manufactured to ASTM F1970, Specification for Special Engineered Fittings, Appurtenances or Valves for use in Poly (Vinyl Chloride) (PVC) or Chlorinated Poly (Vinyl Chloride) (CPVC) Systems.

Working Pressure

Spears® EverTUFF® CTS CPVC Pipe and Fittings have a continuous working pressure rating of 100 psi at 180°F (400 psi at 73°F). Supplemental EverTUFF® Iron Pipe Size (IPS) CPVC Pipe and Fittings, sizes 2-1/2" to 4" have a continuous working pressure rating of 100 psi at 180°F. Larger sizes to 24" may be suitable but will have reduced pressure rating at 180°.

Product Certification

Spears® EverTUFF® CTS CPVC piping systems are certified by NSF International (NSF®) to ASTM D 2846 Specification for Chlorinated Poly (Vinyl Chloride) (CPVC) Plastic Hot and Cold Water Distribution Systems, to the Uniform Plumbing Code (NSF® U.P. Code) and for use in potable water service. Supplemental EverTUFF® Industrial Iron Pipe Size (IPS) CPVC (for 2-1/2" & larger) systems are certified by NSF International (NSF®) to ASTM F 439, Specification for Chlorinated Poly (Vinyl Chloride) (CPVC) Plastic Pipe Fittings, Schedule 80; and ASTM F441, Specification for Chlorinated Poly (Vinyl Chloride) (CPVC) Plastic Pipe, Schedules 40 and 80, to the Uniform Plumbing Code (NSF® U.P. Code) and for use in potable water service. Spears® EverTUFF® CTS CPVC One-step (primerless) CTS-5 Solvent Cement is certified by NSF International (NSF®) to ASTM F 493, Standard Specification for Solvent Cements for Chlorinated Poly (Vinyl Chloride) (CPVC) Plastic Pipe and Fittings, and ASTM D2846, Specification for Chlorinated Poly (Vinyl Chloride) (CPVC) Plastic Hot and Cold Water Distribution Systems. Spears® EverTUFF® CPVC Solvent Cement & Primer (for Iron Pipe Size (IPS) Systems) are certified by NSF International (NSF®) to ASTM F 493, Standard Specification for Solvent Cements for Chlorinated Poly (Vinyl Chloride) (CPVC) Plastic Pipe and Fittings (Cement) and ASTM F 656, Standard Specification for Primers for Use in Solvent Cement Joints of Poly (Vinyl Chloride) (PVC) Plastic Pipe and Fittings (Primer). All Spears® EverTUFF® CTS & Iron Pipe Size (IPS) CPVC products are NSF® certified lead-free in accordance with ANSI/NSF® Standard 61 and 372 for compliance with all State & Federal regulation. Lead free is defined by these requirements as containing no more than a weighted average lead content of =0.25%. Spears® EverTUFF® CTS CPVC to 2" and EverTUFF® Industrial Iron Pipe Size (IPS) CPVC to 6" pipe and fittings are Listed by ICC to ASTM E84 for flame spread/smoke development of less than 25/50 for compliance with requirements for use in return air plenums.

| | |
|---|---|
| ⚠ WARNING | |
|  | <p>Failure to follow instructions and warnings can result in serious personal injury, property damage, and/or product failure.</p> <ul style="list-style-type: none">• Read and understand all instructions before attempting to install any Spears® CPVC Products.• Wear safety glasses, hard hat, and foot protection. |



HAZARD IDENTIFICATION

Definitions for identifying the various hazard levels are provided below.



This safety alert symbol indicates important safety messages. When you see this symbol, be alert to the possibility of personal injury. Carefully read and fully understand the message that follows.

⚠ DANGER

The use of the word "DANGER" identifies an immediate hazard with a likelihood of severe personal injury or death if instructions, including recommended precautions, are not followed.

⚠ WARNING

The use of the word "WARNING" identifies the presence of hazards or unsafe practices that could result in severe personal injury if instructions, including recommended precautions, are not followed.

⚠ CAUTION

The use of the word "CAUTION" identifies possible hazards or unsafe practices that could result in personal injury, product damage, and/or property damage if instructions, including recommended precautions, are not followed.

NOTICE

The use of the word "NOTICE" identifies special instructions that are important but not related to hazards.

Installation Training & Information

Installer training courses are available from Spears® at no charge. To arrange for training or if you need additional copies of this manual, or if you have any questions about the safe installation and use of this system, contact Spears® Manufacturing Company, 15853 Olden Street, Sylmar, CA 91342 USA, Telephone (818) 364-1611 • (800) 862-1499.

SAFETY INSTRUCTIONS

Read and understand this manual before proceeding with the installation and testing of the Spears® EverTUFF® CPVC system. A complete understanding of the instructions provided are requirements for the installer of the Spears® EverTUFF® CPVC system. These instructions contain important information.

1. Inspect the product. Make sure all parts are included with the shipment and that all necessary tools are available for proper installation.
2. Wear safety glasses, hard hat, and foot protection.
3. Avoid dangerous environments. If using electrically powered tools for installation, make sure the area is free from moisture or wetness that could create unsafe working conditions. Keep work areas well lit. Allow sufficient space for measuring and dry-fitting the system.
4. Prevent back injury. Always practice safe lifting and installation techniques.
5. Use only tools specifically designed for plastic pipe and fittings.
6. Work in a well-ventilated area. Ensure that there is proper ventilation when applying primers and cements and/or soldering materials.
7. Wear protective gloves. PVA-coated protective gloves are recommended when applying solvent cement. If hands contact solvent cement, use a waterless, abrasive soap to remove all residue.
8. When solvent cementing, avoid sources of heat or open flame. **DO NOT** smoke while handling solvent cement.
9. Keep work areas clean. Cluttered areas and slippery floors can create hazardous working conditions.
10. Wear hearing protection. Protect your hearing if you are exposed to long periods of very noisy job-site operations.
11. Keep visitors away. All visitors should be kept a safe distance away from the work area.
12. Follow all manufacturers' recommended precautions when cutting or sawing pipes, or when using any heat, flame, or power tools.



MODEL CODES

Spears® EverTUFF® CPVC CTS products meet ASTM D 2846 requirements; CPVC Iron Pipe Size (IPS) products meet ASTM F 441 for pipe, F 439 for fittings; as referenced in the current version of the following model codes.

| Code | Organization |
|--|--|
| BOCA National Plumbing Code | Building Officials and Code Administrators International, Inc. |
| CABO 1- and 2-Family Dwelling Code | Council of American Building Officials |
| Canadian Plumbing Code | National Research Council, Canada |
| International Plumbing Code | BOCA, ICBO, SBCCI, International Code Council |
| National Standard Plumbing Code | National Association of Plumbing-Heating-Cooling Contractors |
| Standard Plumbing Code | Southern Building Code Congress International Inc. |
| Uniform Plumbing Code | International Association of Plumbing and Mechanical Officials |
| International Mechanical Code (return air plenums) | International Code Council |
| Uniform Mechanical Code (return air plenums) | International Association of Plumbing and Mechanical Officials |

LISTING AGENCIES

| Standard | Organization |
|---|--|
| ANSI/NSF® Standards 14 and 61 | NSF International |
| NSF® Standard 392 Lead-Free Certification | NSF International |
| NSF® U.P. Code Certification | NSF International |
| ASTM E-84 | ICC-ES PMG (See PMG Listing No. PMG-1278 at www.icc-es-pmg.org) |





HANDLING AND STORAGE

Spears® EverTUFF® CPVC products resist attack from a large group of chemicals that are corrosive to metallic piping. However, care must be taken to avoid contact with chemicals that are harmful to CPVC. Specific chemicals, or chemical vapors that contact CPVC can weaken or damage the system. Consult with Spears® before using these CPVC products with any questionable materials.

⚠️ WARNING

- **DO NOT** expose Spears® EverTUFF® CPVC CTS or Iron Pipe Size (IPS) Products to edible oils, esters, ketones, or petroleum-based products, such as cutting oils, packing oils, traditional pipe thread paste or dopes, and some lubricants. Do not store or install CPVC products in direct contact with plasticizer containing materials such as electrical tape or certain wire and cable insulations. Do not install CPVC products with metal pipes containing after market Anti-MIC coatings, metal pipes with unapproved factory applied Anti-MIC coatings or non approved Fire Stops. Consult with the chemical manufacturer for compatibility with CPVC or Spears® before use. Contact with incompatible chemicals could cause serious personal injury, property damage, and product damage.

Spears® recommends that CPVC products be stored indoors. If storing outdoors, these products must be covered with a non-transparent material to prevent extended sunlight exposure. Brief exposure to direct sunlight on the job site may result in color fade, but it will not affect the materials physical properties. Spears® EverTUFF® CPVC fittings should be stored in their original containers to keep them free from dirt and to help reduce the possibility of damage. Spears® Solvent Cements should be stored indoors in closed containers between 40°F (5°) and 110°F (44°C).

⚠️ WARNING

- Spears® EverTUFF® CPVC products must not be subjected to prolonged sunlight exposure.
 - For outdoor storage, products must be stored in their original shipping containers, or they must be covered with a non-transparent material.
- Failure to follow these instructions could cause product/system damage, resulting in serious personal injury and/or property damage.

⚠️ WARNING

- **DO NOT** use EverTUFF® CPVC products for refrigerant condensate drains. These may contain Polyol Ester oil, commonly called POE oil, which is a type of Synthetic oil used to lubricate refrigeration compressors and causes stress cracking in CPVC.
- CPVC piping in hydronic heating systems can also occasionally fail because of chemical contamination by POE lubricant oil used in the heat-exchanger refrigerant. Leaks in the heat exchanger can lead to immediate failure of the piping system.

Reasonable care must be exercised in handling Spears® EverTUFF® CPVC products. Do not drop these products or allow anything to drop on them. If improper handling results in scratches, splits, or gouges, the damaged fitting or section of piping must be discarded.

SYSTEM LISTINGS AND USAGE

Penetrating Fire-Rated Walls and Partitions

Spears® EverTUFF® CPVC products can be used within fire-rated buildings, provided all penetrations of fire barriers are constructed so the fire rating of the barrier is not compromised. Most codes accept penetration sealing systems or devices that are UL® Listed or have passed the appropriate ASTM E 119 or E 814 tests. The PPFA manual, "Firestopping: Plastic Pipe in Fire Restrictive Construction" provides more information and lists the applicable test reports. In addition, reference can be made to the current issue of the "Underwriters Laboratories Inc, Directories of Fire Resistance - Through-Penetration Firestop Systems". Before starting an installation, always consult the building codes and local authority having jurisdiction.

⚠️ WARNING

- Some fire-stopping systems contain chemicals that can damage CPVC products. Always consult with Spears® and the fire-stop manufacturer concerning compatibility with CPVC products.
- Failure to follow this instruction could cause product/system damage, resulting in serious personal injury and/or property damage.

Penetrating Studs & Joists

Wood Studs/Joists

Spears® EverTUFF® CPVC piping can be passed through wood studs and joists without use of sleeves or insulators. Holes 1/4" larger than the diameter of the pipe should be drilled in studs or joists to allow for expansion and contraction.

Metal Studs

When EverTUFF® CPVC piping passes through metal studs, plastic insulators, rubber grommets, pipe insulation, or similar devices should be used to prevent abrasion and noise.

⚠️ CAUTION

- Verify that any insulating devices used are chemically compatible with CPVC piping.



Use in Return Air Plenums

Spears® EverTUFF® CTS & Iron Pipe Size (IPS) CPVC pipe and fittings are Listed by ICC for compliance with ASTM E84 Surface Burning Characteristic having flame spread/smoke development of less than 25/50 for use in return air plenums, as required by the Uniform Mechanical Code and the International Mechanical Code. (see PMG Listing PMG-1278 at www.icc-es-pmg.org)

Under Slab Installations

Spears® EverTUFF® CPVC products are approved for under slab installations (with joints) in all model-plumbing codes. When performing under slab installations, it is important to support the pipe evenly on a smooth surface. The bedding and backfill should be sand or clean soil that is free from sharp rocks and other debris that could damage the pipe.

Under slab installations that contain joints must be pressure tested before pouring the slab. NOTE: IAPMO IS 2098, "Installation Standard for CPVC Solvent Cemented Hot and Cold Water Distribution Systems," requires a test at 150 psi for 2 hours. The pipe should be sleeved where it penetrates the slab, along with construction joints within the slab.

Spears® EverTUFF® CTS CPVC pipe is available in coils for under-slab installations. When turning coiled piping up through a slab, into walls, etc., make sure the piping does not kink. Sections of pipe that contain kinks must be cut out and replaced. Do not bend EverTUFF® CTS CPVC 1/2" and 3/4" pipe in a radius tighter than 18"; 1" pipe should not be bent in a radius tighter than 24".

Do not allow termiticides to come into direct and sustained contact with CPVC pipe.

CAUTION

- CAUTION: CPVC is not suitable for in-slab radiant heating systems.

Underground Installation

Trenching

Trench Stability-Ensure that the trench sides are stable. The trench walls shall be sloped or appropriate supports provided to comply with all applicable local, state, and federal requirements for safety.

Trench Width-Trench width below the top of the pipe shall provide adequate room for each of the following requirements:

- (1) Joining pipe in the trench if required.
- (2) Snaking of small diameter solvent cemented pipe from side-to-side in trench.
- (3) Filling and compacting.

Minimum trench widths can be utilized with most solvent-cemented connections by joining the pipe outside the trench and lowering the pipe into place after adequate joint strength has been attained. Trench Bottom-Prepare bottom for direct replacement of the pipe to be continuous, relatively smooth, free of rocks, and provide uniform support. Where ledge rock, hardpan, or boulders are encountered, pad the trench bottom with a bedding of at least 4-in. thick compacted soil.

Trench Depth and Pipe Cover-Sufficient cover must be maintained to accommodate traffic or other concentrated impact loads. Local, state, or federal codes also govern. Pipe intended for winter water service must have a minimum cover equal to or greater than the maximum expected frost penetration depth. A minimum cover of 24 in. for pipe is required when subjected to heavy overhead traffic. In areas of light overhead traffic, a minimum cover of 12 to 18 inches is required.

Thrust Restraint-When installing piping system, thrust restraint is required at changes in direction, or terminal ends, to prevent excessive stress on the system. The mechanical restraints or thrust blocking acts as an anchor between piping and the solid trench wall. The size of the thrust block must be adequate to prevent pipe movement. Consult the system designer.

Bedding and Backfill

Pipe must be uniformly and continuously supported over its entire length on firm stable material. Blocking must not be used to change pipe grade or to intermittently support pipe. The pipe embedment materials must be stable, workable to accommodate placement under the sides of the pipe to provide satisfactory haunching, and readily compactable. Place initial backfill in compacted layers. Particle size of material in contact with pipe should not exceed 1/2 in. for pipe to 4 in. or 3/4 in. for pipe 6 to 8 in.

See ASTM D2774, *Standard Practice for Underground Installation of Thermoplastic Pressure Piping*, for additional detail.

Typical Underground Installation

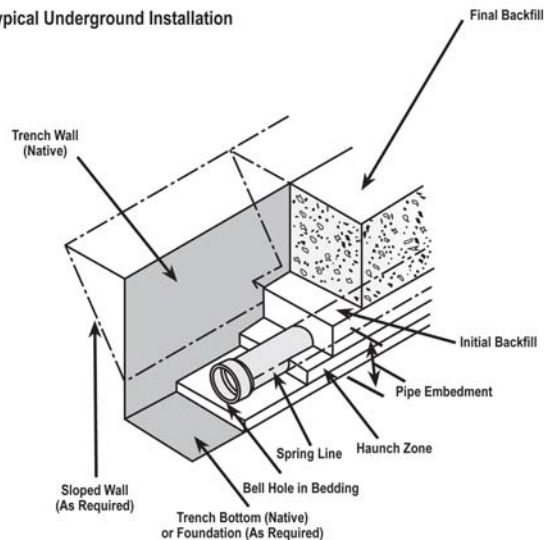



Water Heater Connections

Before attempting to use Spears® EverTUFF® CPVC products in water heater connections, determine if local plumbing codes contain detailed requirements for connections to gas or electric storage-type heaters. **DO NOT** use Spears® EverTUFF® CPVC products with commercial-type, non-storage water heaters or on systems capable of achieving temperatures greater than 180°F.

For areas where local plumbing codes do not have requirements, the following information can be used as a guide for water heater connections:

- On electric water heaters and residential tankless water heaters, CPVC can be joined directly to the heater, using metal-to-CPVC transition fittings.
- On high-efficiency gas water heaters that use plastic vent piping, CPVC can be joined directly to the heater in the same way as an electric water heater connection.
- On all other gas water heaters, there should be at least 6" of clearance between the exhaust flue and any CPVC piping. A minimum of 6" metallic pipe should connect directly to the heater so that the CPVC piping cannot be damaged by the buildup of excessive, radiant heat from the flue.
- A temperature/pressure relief valve should be installed so that the sensing element contacts the water at the top of the heater. T/P Valves are typically designed to discharge at 210° F.
- Spears® EverTUFF® CPVC has been tested to meet or exceed 48 hours at 210°F and are approved by all model codes for use as pressure relief-valve drain lines. A metal-to-CPVC transition fitting should be used to connect the piping to the relief valve. Then, the piping should be continued to the outlet discharge to the atmosphere at an approved location at least 6" above the floor with no threaded end to prevent capping off the drain line. Both the horizontal and vertical pressure relief drain should be supported every 3 feet. For horizontal runs, slope the piping toward the outlet.
- CPVC piping systems are suitable for connection to properly controlled residential tankless water heaters; do not use CPVC pipe and fittings with commercial-type, non-storage water heaters. Residential tankless water heaters are typically limited to a temperature range of 122°F to 140°F. This is within the temperature range of CPVC materials used in plumbing applications. CPVC can be joined directly to the heater, using metal-to-CPVC transition fittings. Verify code requirements prior to installation.

Boiler Connections

⚠ WARNING

- Do not connect CTS CPVC or Schedule 80 Iron Pipe Size (IPS) CPVC directly to a boiler due to excessive heat generated.
- Most boilers do not have suitable temperature variation control.
- Connections must assure that the temperature-pressure does not exceed the capability of the CPVC material.

Failure to follow these instructions could cause product/system damage, resulting in serious personal injury and/or property damage.

Refrigerant Condensate Drains

⚠ WARNING

- Spears® EverTUFF® CPVC products SHOULD NOT be used in refrigerant condensate drains.
- Air conditioning and refrigeration condensate drains frequently contain Polyol Ester oil, commonly called POE oil, used to lubricate refrigeration compressors. POE oil is highly incompatible with CPVC resulting in subsequent leaking. POE can enter the condensate system if the refrigerant circuit is opened during repair work. POE oil is also hygroscopic and can pick up moisture from the surroundings.

Failure to follow these instructions could cause product/system damage, resulting in serious personal injury and/or property damage.

Freeze Protection/Sunlight Exposure

Spears® EverTUFF® CPVC piping must be protected from freezing in all installation locations. Attention shall be paid to local insulating techniques and codes that require a particular method. Use only methods and materials suitable for use with CPVC piping. Where freezing is not an issue, CPVC shall not be installed so as to be subject to direct sunlight after installation and not installed on the surface of a building, unless protected by a covering or a chemically compatible paint, such as water based Latex. Check local codes.

Tub Fillers, Shower Heads and Outside Hose Bibs

CTS CPVC should be connected to tub fillers, showerheads and outside hose bibs with appropriate CPVC to metal threaded transition fittings or a metal nipple. The CPVC system must terminate in the wall.

BASIC JOINT ASSEMBLY FOR CPVC CTS PIPE

⚠ WARNING

- Before assembling any Spears® EverTUFF® CPVC products, inspect all components for cuts, scratches, gouges, split ends, or any other irregularities that have occurred during shipping and handling.

Failure to follow this instruction could cause joint/system failure, resulting in serious personal injury and/or property damage.

Cutting the Pipe

Spears® EverTUFF® piping can be cut easily with a ratchet cutter, wheel-type plastic piping cutter, a power saw, or any other fine-tooth saw.



Be careful not to split the pipe if using a ratchet-type cutter, especially in temperatures below 50°F. If any damage or cracking is evident, cut off at least 2" of the pipe beyond any visible crack.

It is important the cutting tools being used are designed for plastic piping. To ensure that the pipe is cut square, use a miter box when cutting the pipe with a saw. Cutting the pipe as square as possible provides the maximum bonding surface area.

Deburring

Burrs and filings can prevent contact between the pipe and the fitting during assembly and must be removed from the outside and the inside of the pipe. A chamfering tool or file is suitable for this purpose (refer to photos below).



A slight bevel must be placed on the exterior end of the pipe only, as shown below. A slight bevel will ease the entry of the pipe into the socket and minimize the chance of cement being wiped off the fitting.

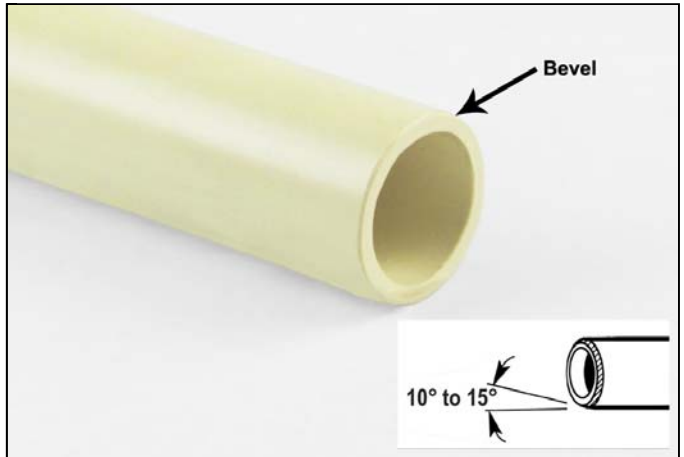

Fitting Preparation

Using a clean, dry rag, wipe any loose dirt and moisture from the fitting's socket and pipe end. Moisture can slow the cure time, and at this stage of assembly, excessive moisture can reduce joint strength.

Check all mating components to ensure tolerances and engagements are compatible. **DO NOT** use any components that appear irregular or do not fit properly. Contact Spears® regarding any questions about usability.

Check the dry fit of the pipe and fitting. The pipe should enter the fittings socket easily 1/3 - 2/3 of the way.

ONE-STEP (PRIMERLESS) CTS CPVC SOLVENT CEMENTING PROCEDURES

Use Spears® EverTUFF® CTS-5 CPVC Solvent Cement that is NSF® Certified to ASTM F493, D2846 and approved for primerless application. Some jurisdictions may require the use of purple primer; check local codes. (See Procedures for Two-Step Solvent Cementing with Primer). The cement must be applied when the pipes and fittings are clean and free from any moisture and debris.



Verify the expiration date located on the solvent cement container. The cement can be used for a period of 2 years from the date stamped on the unopened container. When cementing pipe and fittings in extremely cold temperatures, make sure the cement has not "JELLED." Jelled or expired cement must be discarded in an environmentally friendly fashion, in accordance with local regulations. To prolong the life of solvent cement, keep the containers tightly closed when not in use, and cover the container as much as possible during use. If an unopened solvent cement container is subjected to freezing temperatures, the cement may become extremely thick. Place the closed container in a room temperature area where, after a short time period, the cement will return to a usable condition. **DO NOT** attempt to heat solvent cement.

⚠ WARNING

- Before assembling any Spears® EverTUFF® CPVC products, verify that the solvent cement is within 2 years of the date stamped on the unopened can and that it does not have a "JELLED" appearance. Jelled or expired solvent cement will not provide the strength needed to make a proper joint. Failure to follow this instruction could cause joint/system failure, resulting in serious personal injury and/or property damage.

USING AN APPLICATOR OR NATURAL BRISTLE BRUSH THAT IS AT LEAST 1/2 THE SIZE OF THE PIPE DIAMETER, WORK THE CEMENT INTO THE JOINING SURFACES USING A CONTINUOUS, CIRCULAR MOTION.

Apply the cement in the following sequence, as pictured below:

1. Apply a coat to the pipe.
2. Apply a coat to the fitting.
3. Apply a second coat to the pipe, if required.

Avoid puddling the cement on or within the fitting and pipe. Puddled cement causes excess softening and damage to the CPVC material.



Apply a heavy, even coat of cement to the outside of the pipe end. Work the cement into the joining surfaces using a continuous, circular motion.



Apply a medium coat to the fitting socket. Avoid getting cement in other sockets or threaded connections. A second application of cement must be applied to the pipe end if a 1-1/4 inch and larger joint is being prepared.

⚠ WARNING

- Always apply a second coat of cement to the pipe for joints that are 1-1/4 inch and larger.
 - Avoid puddling the cement on the pipe or within the fitting.
 - Avoid getting cement into other sockets or threaded connections.
- Failure to follow this instruction could cause joint/system failure, resulting in serious personal injury and/or property damage.

Joint Assembly

Immediately insert the pipe into the fittings socket while rotating the pipe 1/4 turn. Align the fitting in the proper orientation at this time. Make sure the pipe bottoms out at the fittings stop.

Hold the assembly for 10 to 15 seconds to ensure initial bonding occurs. A bead of cement must be present around the pipe and fitting juncture. If this bead is not continuous around the sockets shoulder, insufficient cement was applied.



⚠ CAUTION

- CAUTION: If insufficient cement was applied, or the cement hardened before assembly, the joint must be cut out and discarded, and a new joint must be assembled.

Any cement, in excess of the bead, can be wiped off with a dry, clean rag.



Set and Cure Times

- The set and cure times for CPVC solvent cement depend on pipe size, temperature, relative humidity, and tightness of fit. Drying time is faster for drier environments, smaller pipe sizes, high temperatures, and tighter fits.
- Special care must be taken when assembling Spears® EverTUFF® CPVC products in low temperatures (below 40° F) or high temperatures (above 80°F).
- Extra set and handling times must be allowed in colder temperatures. When cementing pipe and fittings in cold temperatures, make sure the cement has not "JELLED." Jelled cement must be discarded.
- In higher temperatures, make sure both surfaces to be joined are still wet with cement during assembly.
- The assembly must be allowed to set, without any stress on the joint, for 5 minutes.
- Following the initial set period, the assembly can be handled carefully by avoiding stress on the joint.

Refer to the table on following page for Minimum Cure Times before pressure testing.

BASIC JOINT ASSEMBLY FOR CPVC IRON PIPE SIZE (IPS) PIPE

Cutting the Pipe

EverTUFF® CPVC Iron Pipe Size (IPS) pipe sizes 2-1/2" & larger can be easily cut with a power saw or fine-toothed saw. A miter box should be used with hand saw to assure pipe is cut as squarely as possible. If any damage or cracking is evident, cut off at least 2" of the pipe beyond any visible crack.

It is important the cutting tools being used are designed for plastic piping. To ensure that the pipe is cut square, use a miter box when cutting the pipe with a saw. Cutting the pipe as square as possible provides the maximum bonding surface area.

Deburring

Burrs and filings can prevent contact between the pipe and the fitting during assembly and must be removed from the outside and the inside of the pipe. A chamfering tool or file is suitable for this purpose. A 10° to 15° bevel should be placed at the end of the pipe to aid entry into the fitting socket and minimize the chance of cement being wiped off.

Fitting Preparation

Using a clean, dry rag, wipe any loose dirt and moisture from the fitting's socket and pipe end. Moisture can slow the cure time, and at this stage of assembly, excessive moisture can reduce joint strength.

⚠ WARNING

- Before assembling any Spears® EverTUFF® CPVC products, inspect all components for cuts, scratches, gouges, split ends, or any other irregularities that have occurred during shipping and handling.

Failure to follow these instructions could cause joint/system failure, resulting in serious personal injury and/or property damage.

Check all mating components to ensure that tolerances and engagements are compatible. DO NOT use any components that appear irregular or do not fit properly. Contact Spears® regarding any questions about usability.

Check the dry fit of the pipe and fitting. The pipe should enter the fitting's socket easily 1/3 - 2/3 of the way.

IRON PIPE SIZE (IPS) CPVC SOLVENT CEMENTING PROCEDURES (TWO-STEP, WITH PRIMER)

Use Spears® CPVC-24 Solvent Cement that is NSF® Certified to ASTM F493, with Spears® Primer-70 that is NSF® Certified to ASTM F656. Most jurisdictions may require the use of orange cement and purple primer, check local codes. The primer and cement must be applied when the pipes and fittings are clean and free from any moisture and debris. Verify the expiration date located on the solvent cement container. The cement can be used for a period of 2 years from the date stamped on the unopened container; primer can be used for 3 years. When cementing pipe and fittings in extremely cold temperatures, make sure the cement has not "JELLED." Jelled or expired cement must be discarded in an environmentally friendly fashion, in accordance with local regulations. To prolong the life of solvent cement, keep the containers tightly closed when not in use, and cover the container as much as possible during use. If an unopened solvent cement container is subjected to freezing temperatures, the cement may become extremely thick. Place the closed container in a room temperature area where, after a short time period, the cement will return to a usable condition. DO NOT attempt to heat or use solvents to thin solvent cement

USE AN APPLICATOR THAT IS AT LEAST 1/2 THE DIAMETER OF THE PIPE TO APPLY PRIMER AND CEMENT

Apply Primer

1. Aggressively work the primer into the fitting socket. Keep the socket and applicator wet until the surface has been softened. Remove any puddles of primer from the socket.
2. Aggressively work the primer into the mating pipe surface. Keep the pipe and applicator wet until the surface has been softened.
3. Apply a second coat of primer to the fitting socket. Immediately begin application of the solvent cement while pipe and fitting surfaces are wet and tacky.



Apply Solvent Cement

Cement must be applied while primer is wet.

1. Apply a full layer of cement to the pipe while aggressively working it in.
2. Immediately apply a medium layer of cement to the fitting socket while aggressively working it in.
3. Apply a second full coat of cement to the pipe while aggressively working it in.

Joint Assembly

Immediately insert the pipe into the fittings socket while rotating the pipe 1/4 turn. Align the fitting in the proper orientation at this time. Make sure the pipe bottoms out at the fittings stop.

Hold the assembly for 10 to 15 seconds to ensure initial bonding occurs. A bead of cement must be present around the pipe and fitting juncture. If this bead is not continuous around the sockets shoulder, insufficient cement was applied.

CTS CPVC TO IRON PIPE SIZE (IPS) CPVC SOLVENT CEMENTING PROCEDURES

For cementing CTS CPVC adapters to Iron Pipe Size (IPS) CPVC components, follow the Iron Pipe Size (IPS) CPVC Solvent Cementing Procedures (Two-step, with primer) described previously.

⚠ CAUTION

- CAUTION: Make sure CPVC-24 cement and primer (two-step process) are used in the CTS to Iron Pipe size (IPS) transitions.

CTS & IRON PIPE SIZE (IPS) MINIMUM CURE TIMES FOR SOLVENT CEMENT BEFORE PRESSURE TESTING

150-psi Maximum Test Pressure

| Piping Size | Ambient Temperature During Cure (Relative Humidity 60% or Less) | | |
|-------------------------|--|--------------|-------------|
| | 60°F to 100°F | 40°F to 60°F | 0°F to 40°F |
| Nominal Diameter inches | | | |
| 1/2 | 15 minutes | 20 minutes | 30 minutes |
| 3/4 | 15 minutes | 20 minutes | 30 minutes |
| 1 | 15 minutes | 20 minutes | 30 minutes |
| 1-1/4 | 15 minutes | 20 minutes | 30 minutes |
| 1-1/2 | 30 minutes | 45 minutes | 1 hour |
| 2 | 30 minutes | 45 minutes | 1 hour |
| 2-1/2 | 1-1/2 Hour | 4 Hours | 72 hours |
| 3 | 1-1/2 Hour | 4 Hours | 72 hours |
| 4 | 1-1/2 Hour | 4 Hours | 72 hours |

NOTE: Hot Water lines should cure for a minimum of 24 hours at temperatures above 60°F and a minimum of 48 hours when installed at temperatures below 40°F before being placed into service. Cut-ins and repairs are often made in less than ideal conditions. Additional curing time is recommended.

⚠ CAUTION

- CAUTION: If insufficient cement was applied, or the cement hardened before assembly, the joint must be cut out and discarded, and a new joint must be assembled.

Any cement, in excess of the bead, can be wiped off with a dry, clean rag.

Set and Cure Times

- The set and cure times for CPVC solvent cement depend on pipe size, temperature, relative humidity, and tightness of fit. Drying time is faster for drier environments, smaller pipe sizes, high temperatures, and tighter fits.
- Special care must be taken when assembling Spears® EverTUFF® CPVC products in low temperatures (below 40°F) or high temperatures (above 80°F).
- Extra set and handling times must be allowed in colder temperatures. When cementing pipe and fittings in cold temperatures, make sure the cement has not "JELLED." Jelled cement must be discarded.
- In higher temperatures, make sure both surfaces to be joined are still wet with cement during assembly.
- The assembly must be allowed to set, without any stress on the joint, for 5 minutes.
- Following the initial set period, the assembly can be handled carefully by avoiding stress on the joint.

Refer to the table on following column for Minimum Cure Times before pressure testing.

⚠ WARNING

- Make sure the cement is allowed to cure, according to the times listed in the chart, for the pipe size and ambient temperature.
- Failure to follow this instruction could cause joint/system failure, resulting in serious personal injury and/or property damage.



TRANSITION JOINTS AND FITTINGS

Spears® EverTUFF® CTS CPVC pipe can be connected to copper, brass, valves, and other materials using a variety of transition fittings including unions, compression fittings, specially reinforced male and female adapters, threaded stainless steel adapters, flanged joints, grooved joints and other readily available transition fittings. Do not thread CPVC pipe and do not use standard CPVC female threaded fittings. Standard CPVC male threaded fittings shall only be used on cold water applications. Spears® produces a wide variety of EverTUFF® threaded transition fittings including Stainless Steel Male & Female Threaded Adapters, Special Reinforced Male Adapters, CPVC Lined Brass-Threaded Male Adapters, Special Reinforced Female Adapters and Gasket Sealed Brass-Threaded Female Adapters. These are recommended for transitions to metal pipe in hot water applications. All approved threaded CPVC joints must be accessible. (See also Water Heater Connections section for additional installation details.)



Spears® EverTUFF® Lead-free Brass Compression Unions are available and are recommended for CTS CPVC transitions to copper tubing and other metal systems. These incorporate a special internal seal.



Standard compression fittings with brass or plastic ferrules can be used. However, PTFE tape should be applied over the brass ferrule to compensate for the dissimilar thermal expansion rates between the brass and CPVC.

Caution must be exercised to prevent overtightening of compression fittings. Use extreme care when soldering any metal system to prevent flame contact with or heat distortion in CTS CPVC pipe and fittings.

Spears® EverTUFF® GripLoc™ Couplings or Caps can be used to transition to copper or CPVC without solvent cement, or to make quick repairs. Allows system to immediately be placed into service. Cap allows immediate termination of line for repairs and can be removed with special removal tool.



Assembling Spears® EverTUFF® CPVC GripLoc™ Transition & Repair Fittings

GripLoc™ CTS CPVC couplings easily transition to copper pipe or to repair or extend CPVC pipe without use of solvent cement. Cut pipe to be joined square, deburr and bevel exterior pipe ends.

Clean connecting pipe surfaces free of dirt and debris. Check for any gouges or nicks that might interfere with GripLoc™ internal O-ring seal.

Measure depth of Coupling (or Cap) from end to pipe stop. Mark this depth on joining pipe.

Carefully insert pipe to engage internal O-ring and push firmly until pipe stop and mark is reached. Joint can be immediately placed into service.

A special removal tool can be used to free the GripLoc™ Coupling or Cap. However, Spears® does not recommend reusing the GripLoc™ fitting due to potential for damage to the internal O-ring. Place tool around pipe at end of fitting, press in to release grippers and pull pipe out.

⚠ WARNING

- **DO NOT** insert fingers in GripLoc™ fitting.
- Gripper rings are sharp and may result in serious injury.



Assembling Gasket Sealed Brass-Threaded Female Adapter Connections

Threaded connections using Spears® EverTUFF® Gasket Sealed Brass-Threaded Female Adapters with O-ring seal at the base of the fitting thread are designed to be assembled without thread sealants. **DO NOT** use ANY thread sealants, tape or paste in these joints. Thread hand tight and tighten snug. This produces a leak-free, reliable seal without problems associated with incompatible thread pastes or improperly applied tape (PTFE) sealants.

⚠ WARNING

- **DO NOT** use any thread sealants on Gasket Sealed Brass-Threaded Female Adapters. Sealants, especially tape (PTFE), may prevent proper joint make-up and result in leaks.
- **DO NOT** over-tighten. Wrench over-tightening of joints may result in fitting damage.

Assembling Standard Threaded Connections

Threaded connections using standard tapered threads (including Spears® EverTUFF® Special Reinforced Female Adapters, Special Reinforced Male Adapters, Brass-Threaded Stainless Steel Threaded Male or Female Adapters and Regular Male Adapters) require the application of a thread sealant that is compatible with CPVC material. Spears® recommends the use of Spears® Blue 75™ Thread Sealant. **DO NOT** use ANY thread sealants on Spears® EverTUFF® Gasket Sealed Brass-Threaded Female Adapters.

⚠ WARNING

- Use only thread sealants recommended by Spears®. Other joint compounds or pastes may contain substances that could cause stress cracks in CPVC or brass materials. Failure to follow this instruction could cause joint/system failure, resulting in serious personal injury and/or property damage.

Apply sealant to the male threads only. Make sure all threads are covered. **DO NOT** clog the waterway with excess sealant.

If PTFE tape is used, Spears® recommends a thickness of at least .0035" that meets or exceeds federal specification A-A-58092 (formerly T-22730A). **DO NOT** use a combination of tape and thread sealant on the same joint.

Apply PTFE tape in the direction of the threads by starting with the first full thread and continuing over the entire thread length. Make sure all threads are covered. Generally, 2 - 3 wraps are sufficient to produce a watertight connection.

⚠ WARNING

- **DO NOT** use more than five wraps of PTFE tape. Excessive tape can cause bunching, resulting in fractures of the plastic fitting or the brass insert due to excessive hoop stress. Failure to follow these instructions could cause joint/system failure, resulting in serious personal injury and/or property damage.

DO NOT over-torque any threaded connections. Generally, one to two turns beyond finger-tight are required for a threaded connection. Factory testing has indicated that 10 - 25 ft-lbs of torque is adequate to obtain a leak-free seal. In standard tapered thread fittings, (not applicable to Gasket Sealed fittings) use only a smooth-jawed wrench or strap wrench when installing threaded connections.

⚠ WARNING

- Tools with teeth **MUST NEVER** be applied to any part of a CPVC fitting. The teeth can damage and weaken CPVC material. Failure to follow these instructions could cause joint/system failure, resulting in serious personal injury and/or property damage.

Flange Connections for Iron Pipe Size (IPS) Connections

Solvent cement flange hub to pipe according to preceding instructions. Use full faced, 1/8" thick gaskets of a material suitable for the intended application having a Shore "A" durometer of approximately 60. Use of well lubricated bolts and flat washers is required. Bolts must be tightened in a 180° opposing pattern to the recommended torque values.

| Flange Size (in.) | Bolt Torque (ft.lb.) |
|-------------------|----------------------|
| 1-1/2 | 12 |
| 2-4 | 25 |
| 6-8 | 40 |

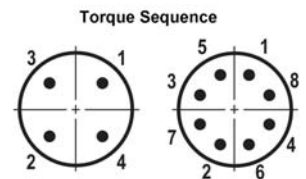

⚠ WARNING

- Use only lubricants recommended by Spears®. Other lubricants may contain substances that could cause stress cracks in CPVC materials. Failure to follow this instruction could cause joint/system failure, resulting in serious personal injury and/or property damage.





VALVES AND STOPS

All Spears® CTS CPVC and Iron Pipe Size (IPS) CPVC valves and stops are certified Lead-Free and listed for potable water service by NSF International.

CTS CPVC

Spears® offers a wide variety of EverTUFF® CTS CPVC Valves and Supply Stops for system flow control that are pressure rated to 100 psi @ 180°F. These include economical Residential or full port Commercial CTS CPVC Ball Valves for quarter turn shutoff throughout the system. CTS CPVC 1/4-turn Angle and Straight Supply Stop valves designed for connection to flexible supply lines serve to connect faucets, toilets and other fixtures.



Iron Pipe Size (IPS) CPVC

A broad selection of industrial grade valves are available for Iron Pipe Size (IPS) CPVC piping, including Ball Valves, Gate Valves, Diaphragm, and Butterfly Valves. These are excellent for controlling flow in Iron Pipe Size (IPS) Commercial Systems sections. Valve pressure ratings vary according to type and size. Contact Spears® for specific valve information. Always check local codes for any restrictions.



SYSTEM PRESSURE TESTING

Hydrostatic pressure testing should commence only after all set and cure times for solvent cemented joints have been satisfied. The system should be pressure tested in accordance with local code requirements following industry accepted practices for thermoplastic systems. Systems should be Hydrostatically Tested (with water). The system must be slowly filled with water and the air bled from the highest and furthest points in the system before test pressure is applied. Failure to do so can cause damage to the piping system and could be harmful to job site personnel should a failure occur. If a leak is found, the affected product must be cut and discarded. A new section can be installed using couplings or other approved means.

Under slab installations that contain joints must be pressure tested before pouring the slab. **NOTE:** IAPMO IS 20, "Installation Standard for CPVC Solvent Cemented Hot and Cold Water Distribution Systems," requires a test at 150 psi for 2 hours.

In freezing temperatures the system should be adequately purged of water after testing to avoid damage from freezing.

ENGINEERING DATA SECTION

Pipe and Fitting Specifications

Spears® EverTUFF® CPVC pipe is produced in SDR 11 dimensions using copper tube size (CTS) outside diameters, as specified in ASTM D 2846 for pipe and fittings. EverTUFF® Industrial Iron Pipe Size (IPS) CPVC pipe is produced in Schedule 80 dimensions using Iron Pipe Size (IPS) outside diameters, as specified in ASTM F441 for pipe and ASTM F439 for fittings. These pipe and fitting systems are NSF® listed for potable water.

CPVC Piping Dimensions

| SDR 11 (Ref. ASTM D 2846) | | | Weight lbs/ft |
|---------------------------|-------------------------|-------------------------|------------------|
| Size Nominal inches | Average OD inches | Average ID inches | |
| 1/2 | 0.625 | 0.469 | 0.09 |
| 3/4 | 0.875 | 0.695 | 0.149 |
| 1 | 1.125 | 0.901 | 0.24 |
| 1-1/4 | 1.375 | 1.105 | 0.353 |
| 1-1/2 | 1.625 | 1.309 | 0.489 |
| 2 | 2.125 | 1.716 | 0.829 |

CPVC Schedule 80 2-1/2" - 6" Piping Dimension

| SDR 80 (Ref. ASTM F441) | | | Weight lbs/ft |
|---------------------------|-------------------------|-------------------------|------------------|
| Size Nominal inches | Average OD inches | Average ID inches | |
| 2-1/2 | 2.875 | 2.289 | 1.674 |
| 3 | 3.500 | 2.684 | 2.242 |
| 4 | 4.500 | 3.786 | 3.277 |
| 6 | 6.625 | 5.709 | 6.258 |



Pressure Ratings

The Spears® EverTUFF® CPVC systems, including both CTS through 2" and Iron Pipe Size (IPS) through 4" piping and joints, have a minimum continuous rated working pressure of 100 psi at 180°F. EverTUFF® 6" pipe has a minimum continuous working pressure of 90 psi at 180°F. CPVC systems have the capability to withstand short-term temperature/pressure increases above 100 psi at 180°F, as evidenced by their ability to consistently surpass the 48 hour, 150 psi test at 210°F. CPVC pipe should not be used where temperatures will consistently exceed 180°F.

| Pressure-Temperature De-Rating Factors For CTS CPVC 4120 SDR 11 Piping Systems | | |
|---|--------|-------------|
| °F | Factor | Rating, PSI |
| 73 | 1.00 | 400 |
| 80 | 1.00 | 400 |
| 90 | 0.91 | 360 |
| 100 | 0.82 | 325 |
| 120 | 0.65 | 260 |
| 140 | 0.50 | 200 |
| 160 | 0.40 | 160 |
| 180 | 0.25 | 100 |

The pressure de-rating factor is the same for all pipe sizes.

Example: Determine the maximum allowable operating pressure for a CTS CPVC piping system with an operating temperature of 140°F. Using de-rating factor of 0.50 for 140° from the above chart, the maximum allowable operating pressure = 400 x 0.50 = 200 psi.

| Pressure-Temperature De-Rating Factors For Iron Pipe Size (IPS) CPVC 4120-6 Schedule 80 Piping Systems 2-1/2" Through 6" | | | | | |
|--|--------|-----------------------|----------------|----------------|----------------|
| °F | Factor | 2-1/2" Rating, PSI | 3" | 4" | 6" |
| | | | Rating, PSI | Rating, PSI | Rating, PSI |
| 73 | 1.00 | 420 | 370 | 320 | 280 |
| 80 | 1.00 | 420 | 370 | 320 | 280 |
| 90 | 0.91 | 382 | 337 | 291 | 255 |
| 100 | 0.83 | 349 | 307 | 266 | 232 |
| 120 | 0.70 | 294 | 289 | 224 | 196 |
| 140 | 0.57 | 239 | 211 | 182 | 160 |
| 160 | 0.44 | 185 | 163 | 141 | 123 |
| 180 | 0.31 | 130 | 110 | 100 | 90 |

Example: Determine the maximum allowable operating pressure for a 2-1/2" piping system with an operating temperature of 140°F. Using de-rating factor of 0.57 for 140° from the above chart, the maximum allowable operating pressure = 420 x 0.57 = 239 psi. The pressure de-rating factor is the same for all pipe sizes. See ASTM F 441 for larger pipe size pressure ratings.

Hydraulic Design

Friction Loss - Friction loss through CPVC pipe is most commonly obtained by the use of the Hazen-Williams equations as expressed below for water:

$$f = .2083 \times \frac{(100)^{1.852}}{C} \times \frac{G^{1.852}}{di^{4.8655}}$$

Where:

f = Friction head of feet of water per 100' for the specific pipe size and I.D.

C = A constant for internal pipe roughness. 150 is the commonly accepted value for CPVC pipe.

G = Flow rate of gallons per minute (U.S. gallons).

di = Inside diameter of pipe in inches.

Compared to other materials on construction for pipe, thermoplastic pipe smoothness remains relatively constant throughout its service life.

Flow Velocities - Velocities for water in feet per second at different GPM's and pipe inside diameters can be calculated as follows:

$$V = .3208 \frac{G}{A}$$

where:

V = Velocity in feet per second

G = Gallons per minute

A = Inside cross sectional area in square inches

While these systems can operate with flow velocities in excess of 10 feet per second, a maximum of 8 feet per second velocity is recommended to extend system life.

While CTS CPVC systems can operate with flow velocities in excess of 10 feet per second, a maximum of 8 feet per second velocity is recommended to extend system life. Spears® recommends Iron Pipe Size (IPS) CPVC systems limited to flow velocities of 5 feet per second.

The following table lists Friction Loss and Flow Velocities for SDR 11 CTS CPVC pipe at different flow rates.



FLOW VELOCITY & FRICTION LOSS

SDR 11

| Flow Rate (Gallons/ Minute) | 1/2" | | | 3/4" | | | 1" | | | 1-1/4" | | | 1-1/2" | | | 2" | | | GPM |
|-----------------------------------|--------------------------------|--|-------------------------------------|--------------------------------|--|-------------------------------------|--------------------------------|--|-------------------------------------|--------------------------------|--|-------------------------------------|--------------------------------|--|-------------------------------------|--------------------------------|--|-------------------------------------|-----|
| | Velocity Feet Per Second | Head Loss Feet of Water Per 100 Ft. | Pressure Loss PSI Per 100 Ft. | Velocity Feet Per Second | Head Loss Feet of Water Per 100 Ft. | Pressure Loss PSI Per 100 Ft. | Velocity Feet Per Second | Head Loss Feet of Water Per 100 Ft. | Pressure Loss PSI Per 100 Ft. | Velocity Feet Per Second | Head Loss Feet of Water Per 100 Ft. | Pressure Loss PSI Per 100 Ft. | Velocity Feet Per Second | Head Loss Feet of Water Per 100 Ft. | Pressure Loss PSI Per 100 Ft. | Velocity Feet Per Second | Head Loss Feet of Water Per 100 Ft. | Pressure Loss PSI Per 100 Ft. | |
| 1 | 1.71 | 3.19 | 1.38 | 0.80 | 0.50 | 0.22 | 0.48 | 0.15 | 0.06 | | | | | | | | | | 1 |
| 2 | 3.42 | 11.53 | 5.00 | 1.60 | 1.82 | 0.79 | 0.96 | 0.53 | 0.23 | | | | | | | | | | 2 |
| 3 | 5.13 | 24.43 | 10.59 | 2.40 | 3.85 | 1.67 | 1.44 | 1.12 | 0.49 | | | | | | | | | | 3 |
| 4 | 6.83 | 41.62 | 18.04 | 3.20 | 6.55 | 2.84 | 1.93 | 1.91 | 0.83 | | | | | | | | | | 4 |
| 5 | 8.54 | 62.91 | 27.27 | 4.00 | 9.91 | 4.29 | 2.41 | 2.89 | 1.25 | | | | | | | | | | 5 |
| 6 | 10.25 | 88.18 | 38.23 | 4.79 | 13.89 | 6.02 | 2.89 | 4.05 | 1.76 | | | | | | | | | | 6 |
| 7 | 11.96 | 117.32 | 50.86 | 5.59 | 18.47 | 8.01 | 3.37 | 5.39 | 2.34 | | | | | | | | | | 7 |
| 8 | 13.67 | 150.23 | 65.13 | 6.39 | 23.66 | 10.26 | 3.85 | 6.90 | 2.99 | | | | | | | | | | 8 |
| 9 | 15.38 | 186.85 | 81.00 | 7.19 | 29.42 | 12.76 | 4.33 | 8.58 | 3.72 | | | | | | | | | | 9 |
| 10 | 17.08 | 227.11 | 98.45 | 7.99 | 35.76 | 15.50 | 4.82 | 10.43 | 4.52 | 3.23 | 3.94 | 1.71 | 2.31 | 1.75 | 0.76 | 1.35 | 0.49 | 0.21 | 10 |
| 15 | | | | 11.99 | 75.78 | 32.85 | 7.22 | 22.11 | 9.58 | 4.84 | 8.35 | 3.62 | 3.47 | 3.71 | 1.61 | 2.03 | 1.03 | 0.45 | 15 |
| 20 | | | | 15.98 | 129.11 | 55.97 | 9.63 | 37.67 | 16.33 | 6.46 | 14.23 | 6.17 | 4.63 | 6.33 | 2.74 | 2.70 | 1.76 | 0.76 | 20 |
| 25 | | | | | | | 12.04 | 56.94 | 24.69 | 8.07 | 21.51 | 9.33 | 5.78 | 9.56 | 4.15 | 3.38 | 2.66 | 1.15 | 25 |
| 30 | | | | | | | 14.45 | 79.82 | 34.60 | 9.68 | 30.15 | 13.07 | 6.94 | 13.40 | 5.81 | 4.05 | 3.73 | 1.62 | 30 |
| 35 | | | | | | | 16.86 | 106.19 | 46.03 | 11.30 | 40.11 | 17.39 | 8.09 | 17.83 | 7.73 | 4.73 | 4.96 | 2.15 | 35 |
| 40 | | | | | | | | | | 12.91 | 51.37 | 22.27 | 9.25 | 22.83 | 9.90 | 5.40 | 6.35 | 2.75 | 40 |
| 45 | | | | | | | | | | 14.52 | 63.89 | 27.70 | 10.41 | 28.40 | 12.31 | 6.08 | 7.89 | 3.42 | 45 |
| 50 | | | | | | | | | | 16.14 | 77.66 | 33.66 | 11.56 | 34.52 | 14.96 | 6.75 | 9.60 | 4.16 | 50 |
| 55 | | | | | | | | | | 17.75 | 92.65 | 40.16 | 12.72 | 41.18 | 17.85 | 7.43 | 11.45 | 4.96 | 55 |
| 60 | | | | | | | | | | | | | 13.88 | 48.38 | 20.97 | 8.10 | 13.45 | 5.83 | 60 |
| 70 | | | | | | | | | | | | | 16.19 | 64.37 | 27.90 | 9.46 | 17.89 | 7.76 | 70 |
| 80 | | | | | | | | | | | | | | | | 10.61 | 22.91 | 9.93 | 80 |
| 90 | | | | | | | | | | | | | | | | 12.16 | 28.50 | 12.35 | 90 |
| 100 | | | | | | | | | | | | | | | | 13.51 | 34.64 | 15.02 | 100 |
| 125 | | | | | | | | | | | | | | | | 16.89 | 52.37 | 22.70 | 125 |



FLOW VELOCITY & FRICTION LOSS

SCHEDULE 80

| Flow Rate (Gallons/ Minute) | 2-1/2" | | | 3" | | | 4" | | | 5" | | | 6" | | | GPM |
|-----------------------------------|----------------------------|-----------------------------------|------------------------------|----------------------------|-----------------------------------|------------------------------|----------------------------|-----------------------------------|------------------------------|----------------------------|-----------------------------------|------------------------------|----------------------------|-----------------------------------|------------------------------|-----|
| | Flow Velocity (ft/sec.) | Friction Loss (FL Water/100ft) | Friction Loss (psi/100ft) | Flow Velocity (ft/sec.) | Friction Loss (FL Water/100ft) | Friction Loss (psi/100ft) | Flow Velocity (ft/sec.) | Friction Loss (FL Water/100ft) | Friction Loss (psi/100ft) | Flow Velocity (ft/sec.) | Friction Loss (FL Water/100ft) | Friction Loss (psi/100ft) | Flow Velocity (ft/sec.) | Friction Loss (FL Water/100ft) | Friction Loss (psi/100ft) | |
| 1 | 0.08 | 0.00 | 0.00 | 0.05 | 0.00 | 0.00 | 0.57 | 0.04 | 0.02 | 0.54 | 0.03 | 0.01 | 0.63 | 0.03 | 0.01 | 1 |
| 2 | 0.16 | 0.01 | 0.00 | 0.10 | 0.00 | 0.00 | 0.71 | 0.06 | 0.03 | 0.63 | 0.04 | 0.02 | 0.75 | 0.04 | 0.02 | 2 |
| 5 | 0.39 | 0.03 | 0.01 | 0.25 | 0.01 | 0.01 | 0.85 | 0.08 | 0.04 | 0.72 | 0.05 | 0.02 | 0.88 | 0.05 | 0.02 | 5 |
| 7 | 0.55 | 0.06 | 0.03 | 0.35 | 0.02 | 0.01 | 1.00 | 0.11 | 0.05 | 0.81 | 0.06 | 0.02 | 0.94 | 0.06 | 0.03 | 7 |
| 10 | 0.78 | 0.12 | 0.05 | 0.50 | 0.04 | 0.02 | 1.14 | 0.14 | 0.06 | 0.90 | 0.07 | 0.03 | 1.00 | 0.07 | 0.03 | 10 |
| 15 | 1.17 | 0.26 | 0.11 | 0.75 | 0.09 | 0.04 | 1.28 | 0.17 | 0.08 | 0.90 | 0.07 | 0.03 | 1.13 | 0.07 | 0.03 | 15 |
| 20 | 1.56 | 0.45 | 0.19 | 1.00 | 0.15 | 0.07 | 1.42 | 0.21 | 0.09 | 0.90 | 0.07 | 0.03 | 1.25 | 0.07 | 0.03 | 20 |
| 25 | 1.95 | 0.68 | 0.29 | 1.24 | 0.23 | 0.10 | 1.57 | 0.25 | 0.10 | 0.90 | 0.07 | 0.03 | 1.37 | 0.07 | 0.03 | 25 |
| 30 | 2.34 | 0.95 | 0.41 | 1.49 | 0.32 | 0.14 | 1.71 | 0.30 | 0.13 | 0.90 | 0.07 | 0.03 | 1.49 | 0.07 | 0.03 | 30 |
| 35 | 2.73 | 1.26 | 0.55 | 1.74 | 0.43 | 0.18 | 1.85 | 0.35 | 0.16 | 0.90 | 0.07 | 0.03 | 1.61 | 0.07 | 0.03 | 35 |
| 40 | 3.11 | 1.62 | 0.70 | 1.99 | 0.54 | 0.24 | 1.99 | 0.39 | 0.17 | 0.90 | 0.07 | 0.03 | 1.73 | 0.07 | 0.03 | 40 |
| 45 | 3.50 | 2.01 | 0.87 | 2.24 | 0.68 | 0.29 | 2.14 | 0.45 | 0.19 | 0.90 | 0.07 | 0.03 | 1.85 | 0.07 | 0.03 | 45 |
| 50 | 3.89 | 2.45 | 1.06 | 2.49 | 0.82 | 0.36 | 2.28 | 0.51 | 0.22 | 0.90 | 0.07 | 0.03 | 1.97 | 0.07 | 0.03 | 50 |
| 60 | 4.67 | 3.43 | 1.49 | 2.99 | 1.15 | 0.50 | 2.56 | 0.63 | 0.27 | 0.90 | 0.07 | 0.03 | 2.24 | 0.07 | 0.03 | 60 |
| 70 | 5.45 | 4.56 | 1.98 | 3.48 | 1.54 | 0.67 | 2.85 | 0.76 | 0.33 | 0.90 | 0.07 | 0.03 | 2.51 | 0.07 | 0.03 | 70 |
| 75 | 5.84 | 5.18 | 2.25 | 3.73 | 1.74 | 0.76 | 3.00 | 0.82 | 0.36 | 0.90 | 0.07 | 0.03 | 2.63 | 0.07 | 0.03 | 75 |
| 80 | 6.23 | 5.84 | 2.53 | 3.98 | 1.97 | 0.85 | 3.15 | 0.88 | 0.38 | 0.90 | 0.07 | 0.03 | 2.75 | 0.07 | 0.03 | 80 |
| 90 | 7.01 | 7.26 | 3.15 | 4.48 | 2.45 | 1.06 | 3.56 | 1.16 | 0.50 | 0.90 | 0.07 | 0.03 | 3.11 | 0.07 | 0.03 | 90 |
| 100 | 7.79 | 8.83 | 3.83 | 4.98 | 2.97 | 1.29 | 3.81 | 1.29 | 0.57 | 0.90 | 0.07 | 0.03 | 3.36 | 0.07 | 0.03 | 100 |
| 125 | 9.73 | 13.34 | 5.78 | 6.22 | 4.49 | 1.95 | 4.27 | 1.62 | 0.70 | 0.90 | 0.07 | 0.03 | 3.81 | 0.07 | 0.03 | 125 |
| 150 | 11.68 | 18.70 | 8.11 | 7.47 | 6.30 | 2.73 | 4.48 | 1.62 | 0.70 | 0.90 | 0.07 | 0.03 | 4.27 | 0.07 | 0.03 | 150 |
| 175 | 13.63 | 24.88 | 10.79 | 8.71 | 8.38 | 3.63 | 4.98 | 2.16 | 0.93 | 0.90 | 0.07 | 0.03 | 4.98 | 0.07 | 0.03 | 175 |
| 200 | 15.57 | 31.86 | 13.81 | 9.96 | 10.73 | 4.65 | 5.70 | 2.76 | 1.20 | 0.90 | 0.07 | 0.03 | 5.70 | 0.07 | 0.03 | 200 |
| 250 | 19.47 | 48.17 | 20.88 | 12.44 | 16.22 | 7.03 | 7.12 | 4.17 | 1.81 | 0.90 | 0.07 | 0.03 | 7.12 | 0.07 | 0.03 | 250 |
| 300 | 23.36 | 67.52 | 29.27 | 14.93 | 22.74 | 9.86 | 8.55 | 5.85 | 2.54 | 0.90 | 0.07 | 0.03 | 8.55 | 0.07 | 0.03 | 300 |
| 350 | | | | | | | 9.97 | 7.78 | 3.37 | 0.90 | 0.07 | 0.03 | 9.97 | 0.07 | 0.03 | 350 |
| 400 | | | | | | | 11.39 | 9.96 | 4.32 | 0.90 | 0.07 | 0.03 | 11.39 | 0.07 | 0.03 | 400 |
| 450 | | | | | | | 12.82 | 12.39 | 5.37 | 0.90 | 0.07 | 0.03 | 12.82 | 0.07 | 0.03 | 450 |
| 500 | | | | | | | | | | 8.98 | 4.90 | 2.13 | 8.98 | 2.04 | 0.89 | 500 |



Typical Friction Loss Through Fittings

Friction loss through fittings is expressed in equivalent feet of the same pipe size and schedule for the system flow rate.

Average Friction Loss for CPVC Fittings in Equivalent Feet of Straight Run Pipe

| Item | 1/2 | 3/4 | 1 | 1-1/4 | 1-1/2 | 2 | 2-1/2 | 3 | 4 | 6 |
|------------|-----|-----|-----|-------|-------|------|-------|------|------|------|
| Tee Run | 1.0 | 1.4 | 1.7 | 2.3 | 2.7 | 4.0 | 4.9 | 6.1 | 7.9 | 12.3 |
| Tee Branch | 3.8 | 4.9 | 6.0 | 7.3 | 8.4 | 12.0 | 14.7 | 16.4 | 22.0 | 32.7 |
| 90° Ell | 1.5 | 2.0 | 2.5 | 3.8 | 4.0 | 5.7 | 6.9 | 7.9 | 11.4 | 16.7 |
| 45° Ell | .8 | 1.1 | 1.4 | 1.8 | 2.1 | 2.6 | 3.1 | 4.0 | 5.1 | 8.0 |

Water Hammer (Hydraulic Shock)

Peak surge pressure resulting from flow interruption in CPVC can produce "hydraulic shock." Some codes prescribe the use of accessible water hammer arresters adjacent to each solenoid operated valve; other codes do not. Water hammer arresters or air chambers are recommended when line pressure is high or where there are high flow fixtures with solenoid valves. Spears® EverTUFF® Water Hammer Arrestors meet the requirements of ASSE 1010 to assure reliable operation. These Water Hammer Arrestors provide easy connection to 1/2" CTS CPVC piping.

Hanger/Support Spacing

Since CPVC pipe is rigid, it requires fewer supports than flexible, plastic systems.

Hangers- Spears® recommends that hangers, designed for supporting CPVC thermoplastics, be used to support CPVC piping. However, some hangers, designed for steel pipe, may be used if their suitability is clearly established. These hangers must be selected to accommodate the specific pipe size. In addition, they cannot contain rough or sharp edges that contact the pipe, and they must not bind the pipe from axial movement that is caused by expansion and contraction.

Vertical Riser Support- Vertical lines (risers) must be properly supported to prevent excessive loading on the lower fitting or other stress concentration areas. Maintain vertical piping in straight alignment with supports at each floor level, or at 10 feet (3.05m) intervals, whichever is less. Hangers and clamps suitable for this purpose include riser clamps or double bolt type clamps that provide a floating system which allows pipe movement due to thermal expansion and contraction when installed. **Clamps and hangers must not compress, distort, cut, abrade or exert compressive stresses on the pipe. The use of riser clamps that utilize compression to support the pipe weight are not recommended.** If possible, locate riser clamps just below a fitting so that the shoulder of the fitting rests against the clamp to support the weight of the vertical column. Support horizontal take-offs with separate riser clamps. Offset

configurations made with at least one change in direction should be made on horizontal run tie-ins to the riser. This will minimize stress on the horizontal connection if riser movement occurs. Do not use a single horizontal run from the riser tee through the wall on hot water lines. Vertical riser support can be made where horizontal take-offs are not present by using a modified coupling adhered to the pipe. This serves as a bearing support with the modified coupling shoulder resting on the riser support clamp. Fittings can be modified in the field to achieve this by cutting a coupling in two, just above the stop at the socket bottom, and then cutting this piece in half lengthwise to provide two halves without the stop. The two halves are then solvent cemented to the pipe at the proper location to position the modified coupling shoulder on the clamp once the joint is allowed to cure properly. (see illustration)

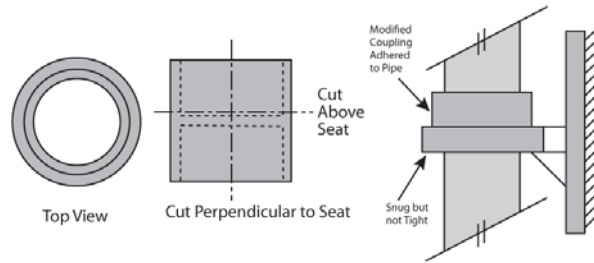

⚠ CAUTION

A modified coupling must ONLY be used to provide support to the riser, and NOT to join two pieces of pipe. The load bearing strength of a modified coupling used for riser support is directly related to the surface area of the coupling used and the integrity of the solvent weld.

Thermal Expansion of Vertical Risers - The effects of thermal expansion on fluid filled vertical risers is typically minimized due to the weight of the fluid column, in combination with restraints used at horizontal takeoffs. The rate of thermal expansion must be calculated based on the temperature change anticipated. Maintain vertical piping in straight alignment with proper supports plus a mid-story guide as specified by the design engineer, to allow for expansion and contraction pipe movement. Mid-story guides should always be used on pipe ≤2" diameter that can be easily deflected, especially on CPVC hot water lines. Since guides act as supports, they should have the same load bearing surface and other requirements of hangers designed for the system. Rigidly attach guides to the structure to prevent lateral movement and deflection, but be sure to allow longitudinal pipe movement. These guidelines for vertical risers do not apply equally to horizontal runs, which must be addressed separately.

Horizontal Runs- Horizontal runs must be braced so that the stress loads (caused by bending or snaking) will not be placed on a fitting or a joint.



Most codes require horizontal runs to have support every 3 feet for 1/2" - 1" diameter pipe and every 4 feet for 1-1/4" and larger diameters (see Table A). However, where not required by code, support spacing can be made according to pipe size and operating temperature (see Table B and Table C). **Always check applicable local codes for hanger spacing requirements.**

Table A - Typical Code Specified Hangers and Support Spacing, SDR 11 Pipe, ASTM D 2846

| Pipe Size (CTS) Nominal inches | Maximum Support Spacing Feet | Water-filled Weight lbs/ft |
|--------------------------------|------------------------------|----------------------------|
| 1/2 | 3 | 0.153 |
| 3/4 | 3 | 0.294 |
| 1 | 3 | 0.486 |
| 1-1/4 | 4 | 0.726 |
| 1-1/2 | 4 | 1.014 |
| 2 | 4 | 1.733 |

Table B - Hanger Spacing (ft.) According to Operating Temperature, SDR 11 Pipe

| Pipe Size (CTS) Nominal inches | Operating Temperature | | | |
|--------------------------------|-----------------------|-------|-------|-------|
| | 73°F | 100°F | 140°F | 180°F |
| 1/2 | 4 | 4 | 3-1/2 | 3 |
| 3/4 | 5 | 4-1/2 | 4 | 3 |
| 1 | 5-1/2 | 5 | 4-1/2 | 3 |
| 1-1/4 | 6 | 5-1/2 | 5 | 4 |
| 1-1/2 | 6-1/2 | 6 | 5-1/2 | 4 |
| 2 | 7-1/2 | 7 | 6-1/2 | 4 |

Table C - Hanger Spacing (ft.) According to Operating Temperature, Schedule 80 Pipe

| Pipe Size (CTS) Nominal inches | Operating Temperature | | | |
|--------------------------------|-----------------------|-------|-------|-------|
| | 73°F | 100°F | 140°F | 180°F |
| 2-1/2 | 8 | 7-1/2 | 6-1/2 | 4 |
| 3 | 8 | 8 | 7 | 4 |
| 4 | 9 | 8-1/2 | 7-1/2 | 4-1/2 |
| 6 | 10 | 9-1/2 | 8 | 5 |

Bending Deflection for EverTUFF® CTS Pipe

Spears® EverTUFF® pipe is ductile, allowing it to be deflected around or away from obstructions during installation. **Notice: DO NOT** install fittings under stress. Pipe or tube must be properly restrained so that stress from deflected pipe is not transmitted to the fitting.

EverTUFF® Pipe, Length in Feet, SDR 11 (ASTM D 2846)

| Pipe Size (CTS) Nominal inches | Pipe Length in Feet (L) | | | | | | | | | | | | | |
|--------------------------------|-------------------------|------|------|------|------|-------|-------|-------|-------|-------|-------|-------|-------|-------|
| | 2 | 5 | 7 | 10 | 12 | 15 | 17 | 20 | 25 | 30 | 35 | 40 | 45 | 50 |
| | 3/4 | | | | | | | | | | | | | |
| 1/2 | 2.1 | 13.2 | 25.8 | 52.6 | 75.8 | 118.4 | 152.1 | 210.6 | 329.0 | 473.8 | 644.8 | | | |
| 3/4 | 1.5 | 9.4 | 18.4 | 37.6 | 54.1 | 84.6 | 108.7 | 150.4 | 235.0 | 338.4 | 460.6 | 601.6 | | |
| 1 | 1.2 | 7.3 | 14.3 | 29.2 | 42.1 | 65.8 | 84.5 | 117.0 | 182.8 | 263.2 | 358.2 | 467.9 | 592.2 | |
| 1-1/4 | 1.0 | 6.0 | 11.7 | 23.9 | 34.5 | 53.8 | 69.1 | 95.7 | 149.5 | 215.3 | 300.1 | 382.8 | 484.5 | 598.2 |
| 1-1/2 | 0.8 | 5.1 | 9.9 | 20.2 | 29.2 | 45.6 | 58.5 | 81.0 | 126.5 | 182.2 | 248.0 | 322.9 | 410.0 | 506.2 |
| 2 | 0.6 | 3.9 | 7.6 | 15.5 | 22.3 | 34.8 | 44.7 | 61.9 | 96.8 | 139.3 | 189.7 | 247.7 | 313.5 | 387.1 |

Maximum Installed Deflections (Snaking) One End Restrained

Notice

DO NOT install fittings under stress. Pipe or tube must be restrained so that stress from deflected pipe is not transmitted to the fitting. Installing fittings under stress may result in system failure and property damage.

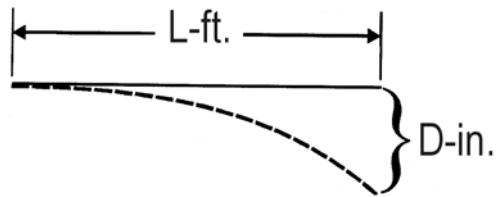

CTS CPVC Technical
CTS Plumbing System Design & Installation Guide



EverTUFF® Pipe, Length in Feet, SDR 11 (ASTM D 2846)

| Pipe Size (CTS) Nominal inches | Pipe Length in Feet (L) | | | | | | | | | | | | | |
|--------------------------------|---|-----|-----|------|------|------|------|------|------|-------|-------|-------|-------|-------|
| | 2 | 5 | 7 | 10 | 12 | 15 | 17 | 20 | 25 | 30 | 35 | 40 | 45 | 50 |
| | Maximum Bending Deflections (73°F) in inches - One End Restrained (d) | | | | | | | | | | | | | |
| 1/2 | 0.5 | 3.3 | 6.4 | 13.2 | 19.0 | 29.9 | 38.0 | 52.7 | 82.3 | 118.5 | 161.2 | 210.6 | 266.6 | 329.1 |
| 3/4 | 0.4 | 2.4 | 4.6 | 9.4 | 13.5 | 21.2 | 27.2 | 37.6 | 58.8 | 84.6 | 115.2 | 150.4 | 190.4 | 235.1 |
| 1 | 0.3 | 1.8 | 3.6 | 7.3 | 10.5 | 16.5 | 21.1 | 29.3 | 45.7 | 65.8 | 89.6 | 117.0 | 148.1 | 182.8 |
| 1-1/4 | 0.2 | 1.5 | 2.9 | 6.0 | 8.6 | 13.5 | 17.3 | 23.9 | 67.4 | 53.8 | 73.3 | 95.7 | 121.2 | 149.6 |
| 1-1/2 | 0.2 | 1.3 | 2.5 | 5.1 | 7.3 | 11.4 | 14.6 | 20.3 | 31.6 | 45.6 | 62.0 | 81.0 | 102.5 | 126.6 |
| 2 | 0.2 | 1.0 | 1.9 | 3.9 | 5.6 | 8.7 | 11.2 | 15.5 | 24.2 | 34.8 | 47.4 | 61.9 | 78.4 | 96.8 |

Maximum Installed Deflections (Snaking) Both Ends Restrained

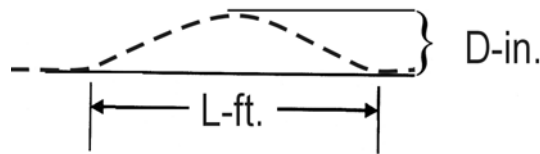

Material Properties

Table I
Modulus of Elasticity and Stress vs. Temperature

| Property | Temperature °F | | | | | | | |
|---|----------------|-------|-------|-------|-------|-------|-------|-------|
| | 73 | 80 | 90 | 100 | 110 | 120 | 140 | 150 |
| Modulus of Elasticity "E" x 10 ⁵ psi | 4.000 | 3.940 | 3.880 | 3.795 | 3.580 | 3.290 | 3.130 | 2.910 |
| Working Stress "S" psi | 2000 | 1875 | 1715 | 1560 | 1415 | 1335 | 1000 | 920 |

Table II
Physical and Thermal Properties

| Property | | CPVC | ASTM |
|--|-----------|------------------------|--------|
| Specific Gravity | "Sp. Gr." | 1.51 | D 792 |
| IZOD Impact Strength (ft-lbs/inch of notch) | | 5.0 | D 256 |
| Modulus of Elasticity, psi | "E" | 4 x10 ⁵ | D 638 |
| Flexural Modulus | | 3.8 x10 ⁵ | D 790 |
| Tensile Strength, psi | | 8,000 | D 638 |
| Compressive Strength, psi | "σ" | 9,000 | D 695 |
| Poisson's Ratio | "ν" | .35 - .38 | - |
| Working Stress @ 73°F, psi | "S" | 1,900 | D 1598 |
| Hazen-Williams "C" Factor | "C" | 150 | - |
| Coefficient of Linear Expansion in/(in °F) | "e" | 3.2 x 10 ⁻⁵ | D 696 |
| Thermal Conductivity BTU/(hr °F ft/in ²) | "k" | 0.95 | C 177 |
| Upper Temperature Limit | "°F" | 205 | |
| Flammability, UL 94 | | V-0 | |
| Electrical Conductivity | | Non-Conductor | |



Expansion and Contraction

⚠ WARNING

Horizontal runs and vertical risers of CPVC piping require additional support and provision for expansion and contraction, compared to metal piping systems. Systems must be designed and installed by qualified personnel, in accordance with the properties and capabilities of the material. Failure to follow these instructions could cause joint or system failure, resulting in serious personal injury and/or property damage.

Expansion Loop Offset Configurations

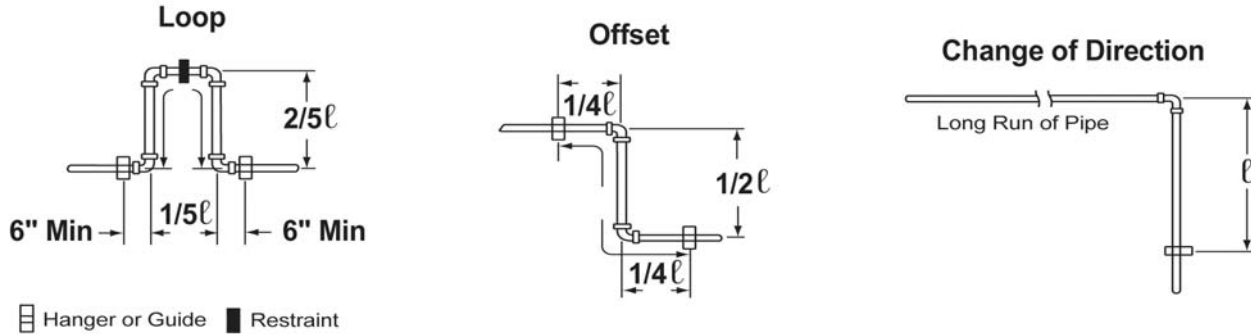

Hangers or guides should only be placed in the loop, offset or change of direction as indicated above. Piping supports should restrict lateral movement and should direct axial movement into the expansion loop. CPVC, like all piping materials, expands and contracts with changes in temperature. The coefficient of linear expansion for CPVC is 3.2×10^{-5} in./in./°F. A 25°F change in temperature will cause an expansion of 1" for a 100-ft straight length. For most installation and operating conditions, expansion and contraction can be accommodated at changes of direction. Based on the following chart, an offset or loop is required on a long, straight run.

Table III: Thermal Expansion for both CTS & Iron Pipe Size (IPS) CPVC Piping in Inches

| Temp Change ΔT °F | Length of Run in feet | | | | | | | | | | | | | |
|---------------------------|---------------------------------------|------|------|------|------|------|------|------|------|------|------|------|------|------|
| | 5 | 10 | 15 | 20 | 25 | 30 | 35 | 40 | 45 | 50 | 70 | 90 | 120 | 160 |
| | Thermal Expansion ΔL (inches) | | | | | | | | | | | | | |
| 20 | 0.04 | 0.08 | 0.12 | 0.15 | 0.19 | 0.23 | 0.27 | 0.31 | 0.35 | 0.38 | 0.54 | 0.69 | 0.92 | 1.23 |
| 30 | 0.06 | 0.12 | 0.17 | 0.23 | 0.29 | 0.35 | 0.40 | 0.46 | 0.52 | 0.58 | 0.81 | 1.04 | 1.38 | 1.84 |
| 40 | 0.08 | 0.15 | 0.23 | 0.31 | 0.38 | 0.46 | 0.54 | 0.61 | 0.69 | 0.77 | 1.08 | 1.38 | 1.84 | 2.46 |
| 50 | 0.10 | 0.19 | 0.29 | 0.38 | 0.48 | 0.58 | 0.67 | 0.77 | 0.86 | 0.96 | 1.34 | 1.73 | 2.30 | 3.07 |
| 60 | 0.12 | 0.23 | 0.35 | 0.46 | 0.58 | 0.69 | 0.81 | 0.92 | 1.04 | 1.15 | 1.61 | 2.07 | 2.76 | 3.69 |
| 70 | 0.13 | 0.27 | 0.40 | 0.54 | 0.67 | 0.81 | 0.94 | 1.08 | 1.21 | 1.34 | 1.88 | 2.42 | 3.23 | 4.30 |
| 80 | 0.15 | 0.31 | 0.46 | 0.61 | 0.77 | 0.92 | 1.08 | 1.23 | 1.38 | 1.54 | 2.15 | 2.76 | 3.69 | 4.92 |
| 90 | 0.17 | 0.35 | 0.52 | 0.69 | 0.86 | 1.04 | 1.21 | 1.38 | 1.56 | 1.73 | 2.42 | 3.11 | 4.15 | 5.53 |
| 100 | 0.19 | 0.38 | 0.58 | 0.77 | 0.96 | 1.15 | 1.34 | 1.54 | 1.73 | 1.92 | 2.69 | 3.46 | 4.61 | 6.14 |

$\Delta L = 12 e l (\Delta T)$
 $e = 3.2 \times 10^{-5}$ in./in./°F (Coefficient of Linear Expansion - Table II)
 L = Length of Run in feet
 ΔT = Temperature Change in °F

Example: How much will a 40-ft run of 2" CPVC pipe expand if the expected ambient temperature will range from 45°F to 85°F?
 $\Delta L = 12 e l (\Delta T)$
 $\Delta L = 12 (.000032) \times 40 \times 40$
 $\Delta L = .61"$



Table IV: Expansion Loop Length for CTS CPVC SDR 11 Piping in Inches

| Nominal Pipe Size | Avg. O.D. | Length of Run in feet | | | | | | | | | | | | | |
|-------------------|-----------|--|----|----|----|----|----|----|----|----|----|----|----|-----|-----|
| | | 5 | 10 | 15 | 20 | 25 | 30 | 35 | 40 | 45 | 50 | 70 | 90 | 120 | 160 |
| | | Length of Loop (inches) Temperature Change (ΔT) = 100°F - 30°F = 70°F | | | | | | | | | | | | | |
| 1/2 | 0.625 | 6 | 8 | 10 | 11 | 13 | 14 | 15 | 16 | 17 | 18 | 21 | 24 | 27 | 32 |
| 3/4 | 0.875 | 7 | 9 | 11 | 13 | 15 | 16 | 18 | 19 | 20 | 21 | 25 | 28 | 32 | 38 |
| 1 | 1.125 | 8 | 11 | 13 | 15 | 17 | 18 | 20 | 21 | 23 | 24 | 28 | 32 | 37 | 43 |
| 1-1/4 | 1.375 | 8 | 12 | 14 | 17 | 19 | 20 | 22 | 24 | 25 | 26 | 31 | 35 | 41 | 47 |
| 1-1/2 | 1.625 | 9 | 13 | 16 | 18 | 20 | 22 | 24 | 26 | 27 | 29 | 34 | 38 | 44 | 51 |
| 2 | 2.125 | 10 | 15 | 18 | 21 | 23 | 25 | 27 | 29 | 31 | 33 | 39 | 44 | 51 | 58 |

Note: Table IV is based on 70°F temperature change. Values rounded.

$$l = \sqrt{\frac{3ED(\Delta L)}{2S}}$$

l = Length of Expansion Loop in Inches ΔL = Change in Length of Pipe Due to Change in Temperature (Table III)
 E = Modulus of Elasticity at 100°F (Table I) S = Working Stress at 100°F (Table 1)
 D = Average OD of Pipe

Example: How much expansion can be expected in a 200-ft run of 2" CPVC pipe? How long should the expansion loop be to compensate for the expansion?(The expected temperature range will be from 40°F to 110°F.)

First Find: ΔT = (Change in Temperature)
 ΔT = T2 - T1
 ΔT = 110°F - 40°F
 ΔT = 70°F

To Find ΔL = (Amount of Expansion in inches from Table III)
 ΔL = ΔL of 160 ft with a ΔT of 70°F + ΔL of 40 ft. with a ΔT of 70°F
 ΔL = 4.30" + 1.08"
 ΔL = 5.38"
 - OR -
 ΔL = 12 eL (ΔT)
 e = 3.2 x 10⁻⁵(from Table II)
 L = Length of Run in Feet
 ΔT = Change in Temperature in °F
 ΔL = 12 x 0.000032 x 200 x 70
 ΔL = 5.38"

$$l = \sqrt{\frac{3ED(\Delta L)}{2S}}$$

l = Length of Expansion Loop in Inches
 E = Modulus of Elasticity at Maximum Temperature from Table I
 D = Average OD of Pipe
 ΔL= Change in Length of Pipe Due to Change in Temperatures
 S = Working Stress at 110°F(Refer to Table I)

To find the length of the expansion loop or offset in inches:

$$l = \sqrt{\frac{3ED(\Delta L)}{2S}}$$

l = Length of Expansion Loop in Inches
 E = Modulus of Elasticity at Maximum Temperature from Table I
 D = Average Outside diameter of the Pipe from Table IV
 S = Working Stress at Maximum Temperature from Table I
 ΔL= Change in Length of Pipe Due to Change in Temperature from Table III

$$l = \sqrt{\frac{3 \times 346,000 \times 2.125 \times 5.38}{2 \times 1345}}$$

$$l = \sqrt{4339}$$

$$l = 65.87$$



Spears® GripLoc™ CTS CPVC Couplings are designed to provide safe, reliable connections for transition to copper pipe and to aid in quick repairs without use of solvent cement. Permanent installation and sealing prevents inadvertent separation of pipe - an extremely important aspect of use in hot water distribution systems.



- ✓ Stainless Steel Gripper Ring Permanently Holds Pipe Joint in Place
- ✓ Internal High Grade EPDM O-ring Seals Provides Permanent, Reliable Sealing
- ✓ Excellent Transition Fitting Between Copper and Superior CTS CPVC System Installations
- ✓ Eliminates Downtime In Making System Repairs- Even Wet Lines Will Not Affect Sealing
- ✓ Suitable for Use In Underground Direct Burial Applications as a Manufactured Joint
- ✓ NSF® Certified Lead-Free for Use in Potable Water Systems

Produced in nominal CTS CPVC Pipe sizes 1/2", 3/4" and 1". Pressure rated to 100 psi @ 180°F

WARNING: DO NOT INSERT FINGERS IF USED ON GROUNDED COPPER-TO-COPPER, A GROUND CABLE IS REQUIRED TO BRIDGE CPVC.



Excellent Transition Fitting Between Copper and CTS CPVC System Installations

Progressive Products From Spears® Innovation & Technology

GripLoc™ Coupling Installation

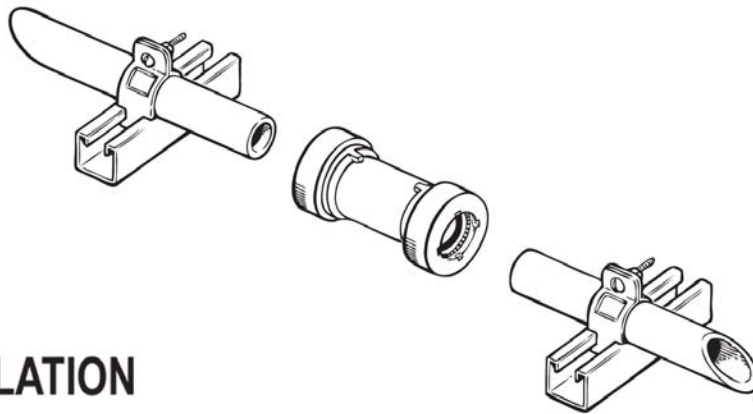

EASY INSTALLATION

STEP 1 Cut pipe square. Deburr and bevel.

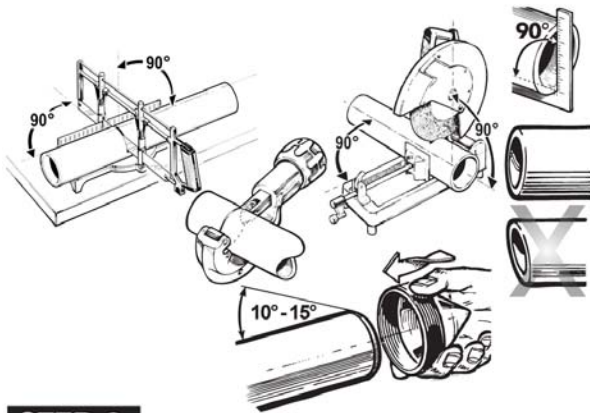

STEP 2 Measure from pipe stop to the end of the coupling.

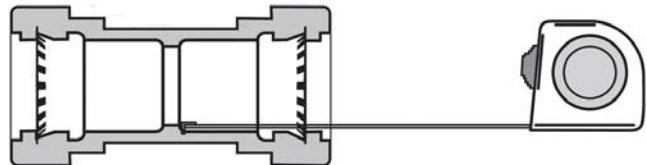

STEP 3 Measure and mark pipe.

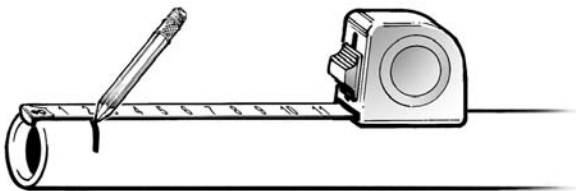

STEP 4 Insert pipe all the way to mark. Pipe should bottom out at the pipe stop.

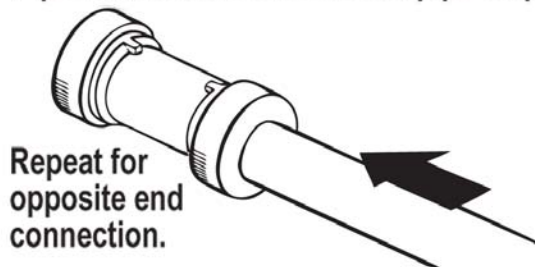

WARNING: DO NOT INSERT FINGERS. ENSURE THAT PIPE AND FITTINGS ARE FREE OF DIRT AND DEBRIS PRIOR TO INSTALLATION.



CTS CPVC Technical CTS Product Dimensions

CPVC 41, SDR 11 PIPE DIMENSIONS (CTS) ASTM D 2846, D 2846M

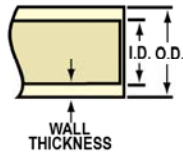

| Nominal Pipe Size In. | Mean Outside Diameter In. | O.D. Tolerance In. | Minimum Wall Thickness In. |
|-----------------------|---------------------------|--------------------|----------------------------|
| 1/2 | 0.625 | ±0.003 | 0.068 |
| 3/4 | 0.875 | ±0.003 | 0.080 |
| 1 | 1.125 | ±0.003 | 0.102 |
| 1-1/4 | 1.375 | ±0.003 | 0.125 |
| 1-1/2 | 1.625 | ±0.004 | 0.148 |
| 2 | 2.125 | ±0.004 | 0.193 |

CPVC 41, SDR 11 SOCKET DIMENSIONS (CTS) ASTM D 2846, D 2846M

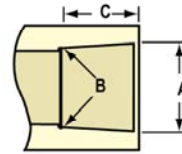

| Nominal Size In. | Diameter | | | Socket Length Minimum C |
|------------------|------------|----------|---------------|-------------------------|
| | Entrance A | Bottom B | Tolerance In. | |
| 1/2 | 0.633 | 0.619 | ±0.003 | 0.500 |
| 3/4 | 0.884 | 0.870 | ±0.003 | 0.700 |
| 1 | 1.1345 | 1.121 | ±0.003 | 0.900 |
| 1-1/4 | 1.386 | 1.372 | ±0.003 | 1.100 |
| 1-1/2 | 1.640 | 1.622 | ±0.004 | 1.300 |
| 2 | 2.141 | 2.123 | ±0.004 | 1.700 |

Injection Molded Dimension References:

G = (LAYING LENGTH) intersection of center lines to bottom of socket/thread; 90° elbows, tees, crosses; ± 1/32 inch.

H = Intersection of center lines to face of fitting; 90° elbows, tees, crosses; ± 1/32 inch.

J = Intersection of center lines to bottom of socket/thread; 45° elbows; ± 1/32 inch.

L = Overall length of fittings; ± 1/16 inch.

M = Outside diameter of socket/thread hub; ± 1/16 inch.

N = Socket bottom to socket bottom; couplings; ± 1/16 inch.

W = Height of cap; ± 1/16 inch.

COPPER TUBE SIZE (CTS) CPVC PIPE

| Nominal Pipe Size In. | AVG. O.D | AVG. I.D | MIN. Wall | MAX. W.P. P.S.I | LBS./FT | Lgths./Carton |
|-----------------------|----------|----------|-----------|-----------------|---------|---------------|
| 1/2 | Entrance | 0.469 | 0.068 | 400 | .090 | 50 |
| 3/4 | 0.875 | 0.695 | 0.080 | 400 | .149 | 25 |
| 1 | 1.125 | 0.901 | 0.102 | 400 | .353 | 10 |
| 1-1/4 | 1.375 | 1.105 | 0.125 | 400 | .353 | 10 |
| 1-1/2 | 1.625 | 1.309 | 0.148 | 400 | .489 | 6 |
| 2 | 2.125 | 1.716 | 0.193 | 400 | .829 | 4 |

Standard Length- 10 Feet · All pipe is packed in boxes sold in carton quantities only.
Pipe has UL 94 V-O rating · FO for water, non shock, at 73.4°F with solvent welded joints.



CTS CPVC Technical
CTS Product Dimensions



Tee

Socket x Socket x Socket
 NSF® Certified Lead Free

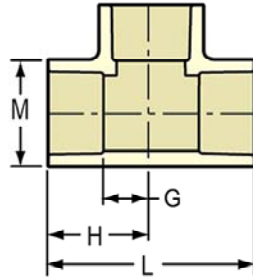

| Part Number | Size | G | H | L | M | Approx. Wt. (Lbs.) |
|-------------|-------|--------|---------|---------|---------|--------------------|
| 4101-005 | 1/2 | 13/32 | 15/16 | 1-7/8 | 27/32 | .03 |
| 4101-007 | 3/4 | 17/32 | 1- 1/4 | 2- 1/2 | 1- 3/32 | .05 |
| 4101-010 | 1 | 21/32 | 1-19/32 | 3-3/16 | 1- 3/8 | .10 |
| 4101-012 | 1-1/4 | 25/32 | 1-29/32 | 3-13/16 | 1-21/32 | .17 |
| 4101-015 | 1-1/2 | 29/32 | 2-1/4 | 4-1/2 | 1-15/16 | .28 |
| 4101-020 | 2 | 1-3/16 | 2-29/32 | 5-13/16 | 2- 9/16 | .61 |

Tee - Reducing

Socket x Socket x Socket
 NSF® Certified Lead Free

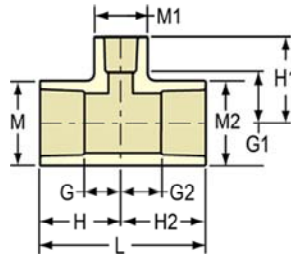

| Part Number | Size | G | G1 | G2 | H | H1 | H2 | L | M | M1 | M2 | Approx. Wt. (Lbs.) |
|-----------------------|-----------------|-------|---------|---------|---------|---------|---------|---------|---------|---------|---------|--------------------|
| 4101-074 | 1/2X1/2X3/4 | 7/16 | 13/32 | 7/16 | 31/32 | 1- 1/8 | 31/32 | 1-15/16 | 27/32 | 1- 3/32 | 27/32 | .04 |
| 4101-094 | 3/4X1/2X1/2 | 7/16 | 1/2 | 1/2 | 1-5/32 | 1- 1/32 | 31/32 | 2- 1/8 | 1- 3/32 | 27/32 | 27/32 | .04 |
| 4101-095 | 3/4X1/2X3/4 | 17/32 | 17/32 | 19/32 | 1-1/4 | 1- 1/4 | 1- 1/8 | 2-3/8 | 1- 3/32 | 1- 3/32 | 27/32 | .05 |
| 4101-101 | 3/4X3/4X1/2 | 13/32 | 1/2 | 13/32 | 1- 1/8 | 1- 1/32 | 1- 1/8 | 2- 1/4 | 1- 3/32 | 7/8 | 1- 3/32 | .04 |
| 4101-102 ¹ | 3/4X3/4X1 | 31/32 | 21/32 | 31/32 | 1-23/32 | 1-19/32 | 1-23/32 | 3-7/16 | 1-3/8 | 1-3/8 | 1-3/8 | .15 |
| 4101-120 ¹ | 1X1/2X1/2 | 21/32 | 1-9/32 | 1-9/32 | 1-19/32 | 1-13/16 | 1-13/16 | 3-13/32 | 1-3/8 | 1-3/8 | 1-3/8 | .17 |
| 4101-121 ¹ | 1X1/2X3/4 | 21/32 | 31/32 | 1-9/32 | 1-19/32 | 1-23/32 | 1-13/16 | 3-13/32 | 1-3/8 | 1-3/8 | 1-3/8 | .16 |
| 4101-122 ¹ | 1X1/2X1 | 21/32 | 21/32 | 1-9/32 | 1-19/32 | 1-19/32 | 1-13/16 | 3-13/32 | 1-3/8 | 1-3/8 | 1-3/8 | .14 |
| 4101-124 ¹ | 1X3/4X1/2 | 21/32 | 1-9/32 | 31/32 | 1-19/32 | 1-13/16 | 1-23/32 | 3-5/16 | 1-3/8 | 1-3/8 | 1-3/8 | .16 |
| 4101-125 | 1X3/4X3/4 | 17/32 | 11/16 | 17/32 | 1-15/32 | 1-13/32 | 1- 1/4 | 2-23/32 | 1-3/8 | 1-1/8 | 1- 3/32 | .07 |
| 4101-126 ¹ | 1X3/4X1 | 21/32 | 21/32 | 1 | 1-19/32 | 1-19/32 | 1-23/32 | 3-5/16 | 1-3/8 | 1-3/8 | 1-3/8 | .12 |
| 4101-130 | 1X1X1/2 | 13/32 | 11/16 | 13/32 | 1-11/32 | 1- 7/32 | 1-11/32 | 2-11/16 | 1- 3/8 | 27/32 | 1- 3/8 | .07 |
| 4101-131 | 1X1X3/4 | 9/16 | 11/16 | 9/16 | 1-15/32 | 1-13/16 | 1-15/32 | 2-15/16 | 1- 3/8 | 1-1/8 | 1- 3/8 | .08 |
| 4101-138 ¹ | 1-1/4X1/2X1/2 | 25/32 | 1-11/16 | 1-21/32 | 1-29/32 | 2-3/16 | 2- 3/16 | 4- 3/32 | 1-21/32 | 1-21/32 | 1-21/32 | .30 |
| 4101-139 ¹ | 1-1/4X1/2X3/4 | 25/32 | 1-7/16 | 1-21/32 | 1-29/32 | 2-5/32 | 2- 3/16 | 4- 3/32 | 1-21/32 | 1-21/32 | 1-21/32 | .30 |
| 4101-142 ¹ | 1-1/4X1/2X1-1/4 | 25/32 | 25/32 | 1-21/32 | 1-29/32 | 1-29/32 | 2- 3/16 | 4- 3/32 | 1-21/32 | 1-21/32 | 1-21/32 | .24 |
| 4101-146 ¹ | 1-1/4X3/4X1/2 | 25/32 | 1-11/16 | 1-7/16 | 1-29/32 | 2-3/16 | 2-5/32 | 4-1/16 | 1-21/32 | 1-21/32 | 1-21/32 | .30 |
| 4101-147 ¹ | 1-1/4X3/4X3/4 | 25/32 | 1-7/16 | 1-7/16 | 1-29/32 | 2-5/32 | 2-5/32 | 4-1/16 | 1-21/32 | 1-21/32 | 1-21/32 | .30 |
| 4101-148 ¹ | 1-1/4X3/4X1 | 25/32 | 1-3/16 | 1-7/16 | 1-29/32 | 2-1/8 | 2-5/32 | 4-1/16 | 1-21/32 | 1-21/32 | 1-21/32 | .28 |
| 4101-149 ¹ | 1-1/4X3/4X1-1/4 | 25/32 | 25/32 | 1- 7/16 | 1-29/32 | 1-29/32 | 2-5/32 | 4-1/16 | 1-21/32 | 1-21/32 | 1-21/32 | .24 |
| 4101-156 ¹ | 1-1/4X1X1/2 | 25/32 | 1-11/16 | 1-3/16 | 1-29/32 | 2- 3/16 | 2-1/8 | 4-1/32 | 1-21/32 | 1-21/32 | 1-21/32 | .28 |
| 4101-157 ¹ | 1-1/4X1X3/4 | 25/32 | 1-7/16 | 1-3/16 | 1-29/32 | 2-5/32 | 2-1/8 | 4-1/32 | 1-21/32 | 1-21/32 | 1-21/32 | .28 |
| 4101-158 ¹ | 1-1/4X1X1 | 11/16 | 3/4 | 11/16 | 1-13/16 | 1-5/8 | 1-5/8 | 3-3/8 | 1-11/16 | 1-3/8 | 1-11/16 | .26 |



CTS CPVC Technical
CTS Product Dimensions

Tee - Reducing

Socket x Socket x Socket
NSF® Certified Lead Free

(Continued)

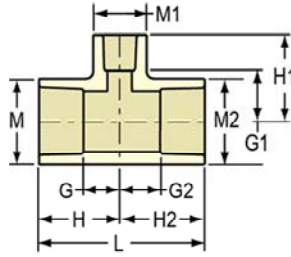

| Part Number | Size | G | G1 | G2 | H | H1 | H2 | L | M | M1 | M2 | Approx. Wt. (Lbs.) |
|-----------------------|-------------------|---------|---------|---------|---------|---------|---------|---------|---------|---------|---------|--------------------|
| 4101-159 ¹ | 1-1/4X1X1-1/4 | 25/32 | 25/32 | 1-3/16 | 1-29/32 | 1-29/32 | 2-1/8 | 4-1/32 | 1-21/32 | 1-21/32 | 1-21/32 | .22 |
| 4101-166 | 1-1/4X1-1/4X1/2 | 13/32 | 27/32 | 13/32 | 1-17/32 | 1-11/32 | 1-17/32 | 3-1/16 | 1-21/32 | 13/16 | 1-21/32 | .12 |
| 4101-168 | 1-1/4X1-1/4X1 | 11/16 | 27/32 | 11/16 | 1-13/16 | 1-3/4 | 1-13/16 | 3-5/8 | 1-21/32 | 1-3/8 | 1-21/32 | .16 |
| 4101-167 | 1-1/4X1-1/4X3/4 | 17/32 | 27/32 | 17/32 | 1-21/32 | 1-9/16 | 1-21/32 | 3-5/16 | 1-11/16 | 1-1/8 | 1-11/16 | .13 |
| 4101-169 ¹ | 1-1/4X1-1/4X1-1/2 | 1-3/8 | 29/32 | 1-3/8 | 2-1/2 | 2-1/4 | 2-1/2 | 5 | 1-15/16 | 1-15/16 | 1-15/16 | .40 |
| 4101-173 ¹ | 1-1/2X1/2X1/2 | 29/32 | 2-1/32 | 2-1/32 | 2-1/4 | 2-9/16 | 2-9/16 | 4-13/16 | 1-15/16 | 1-15/16 | 1-15/16 | .49 |
| 4101-174 ¹ | 1-1/2X1/2X3/4 | 29/32 | 1-27/32 | 2-1/32 | 2-1/4 | 2-9/16 | 2-9/16 | 4-13/16 | 1-15/16 | 1-15/16 | 1-15/16 | .48 |
| 4101-175 ¹ | 1-1/2X1/2X1 | 29/32 | 1-9/16 | 2-1/32 | 2-1/4 | 2-1/2 | 2-9/16 | 4-13/16 | 1-15/16 | 1-15/16 | 1-15/16 | .48 |
| 4101-176 ¹ | 1-1/2X1/2X1-1/4 | 29/32 | 1-3/8 | 2-1/32 | 2-1/4 | 2-1/2 | 2-9/16 | 4-13/16 | 1-15/16 | 1-15/16 | 1-15/16 | .44 |
| 4101-177 ¹ | 1-1/2X1/2X1-1/2 | 29/32 | 29/32 | 2-1/32 | 2-1/4 | 2-1/4 | 2-9/16 | 4-13/16 | 1-15/16 | 1-15/16 | 1-15/16 | .38 |
| 4101-182 ¹ | 1-1/2X3/4X1/2 | 29/32 | 2-1/32 | 1-27/32 | 2-1/4 | 2-9/16 | 2-9/16 | 4-13/16 | 1-15/16 | 1-15/16 | 1-15/16 | .48 |
| 4101-184 ¹ | 1-1/2X3/4X3/4 | 29/32 | 1-27/32 | 1-27/32 | 2-1/4 | 2-9/16 | 2-9/16 | 4-13/16 | 1-15/16 | 1-15/16 | 1-15/16 | .48 |
| 4101-185 ¹ | 1-1/2X3/4X1 | 29/32 | 1-9/16 | 1-27/32 | 2-1/4 | 2-1/2 | 2-9/16 | 4-13/16 | 1-15/16 | 1-15/16 | 1-15/16 | .48 |
| 4101-186 ¹ | 1-1/2X3/4X1-1/4 | 29/32 | 1-3/8 | 1-27/32 | 2-1/4 | 2-1/2 | 2-9/16 | 4-13/16 | 1-15/16 | 1-15/16 | 1-15/16 | .44 |
| 4101-188 ¹ | 1-1/2X3/4X1-1/2 | 29/32 | 29/32 | 1-27/32 | 2-1/4 | 2-1/4 | 2-9/16 | 4-13/16 | 1-15/16 | 1-15/16 | 1-15/16 | .38 |
| 4101-193 ¹ | 1-1/2X1X1/2 | 29/32 | 2-1/32 | 1-9/16 | 2-1/4 | 2-9/16 | 2-1/2 | 4-3/4 | 1-15/16 | 1-15/16 | 1-15/16 | .48 |
| 4101-194 ¹ | 1-1/2X1X3/4 | 29/32 | 1-27/32 | 1-9/16 | 2-1/4 | 2-9/16 | 2-1/2 | 4-3/4 | 1-15/16 | 1-15/16 | 1-15/16 | .48 |
| 4101-195 ¹ | 1-1/2X1X1 | 29/32 | 1-9/16 | 1-9/16 | 2-1/4 | 2-1/2 | 2-1/2 | 4-3/4 | 1-15/16 | 1-15/16 | 1-15/16 | .47 |
| 4101-196 ¹ | 1-1/2X1X1-1/4 | 29/32 | 1-3/8 | 1-9/16 | 2-1/4 | 2-1/2 | 2-1/2 | 4-3/4 | 1-15/16 | 1-15/16 | 1-15/16 | .44 |
| 4101-197 ¹ | 1-1/2X1X1-1/2 | 29/32 | 29/32 | 1-19/32 | 2-1/4 | 2-1/4 | 2-1/2 | 4-3/4 | 1-15/16 | 1-15/16 | 1-15/16 | .38 |
| 4101-199 ¹ | 1-1/2X1-1/4X1/2 | 29/32 | 2-1/32 | 1-3/8 | 2-1/4 | 2-9/16 | 2-1/2 | 4-3/4 | 1-15/16 | 1-15/16 | 1-15/16 | .44 |
| 4101-201 ¹ | 1-1/2X1-1/4X3/4 | 29/32 | 1-7/8 | 1-3/8 | 2-1/4 | 2-9/16 | 2-1/2 | 4-3/4 | 1-15/16 | 1-15/16 | 1-15/16 | .44 |
| 4101-202 ¹ | 1-1/2X1-1/4X1 | 29/32 | 1-5/8 | 1-3/8 | 2-1/4 | 2-1/2 | 2-1/4 | 4-3/4 | 1-15/16 | 1-15/16 | 1-15/16 | .44 |
| 4101-203 ¹ | 1-1/2X1-1/4X1-1/4 | 29/32 | 1-3/8 | 1-3/8 | 2-1/4 | 2-1/2 | 2-1/2 | 4-3/4 | 1-15/16 | 1-15/16 | 1-15/16 | .40 |
| 4101-204 ¹ | 1-1/2X1-1/4X1-1/2 | 29/32 | 29/32 | 1-3/8 | 2-1/4 | 2-1/4 | 2-1/2 | 4-3/4 | 1-15/16 | 1-15/16 | 1-15/16 | .34 |
| 4101-209 | 1-1/2X1-1/2X1/2 | 13/32 | 31/32 | 13/32 | 1-3/4 | 1-1/2 | 1-3/4 | 3-1/2 | 1-15/16 | 7/8 | 1-15/16 | .18 |
| 4101-210 | 1-1/2X1-1/2X3/4 | 17/32 | 31/32 | 17/32 | 1-7/8 | 1-11/16 | 1-7/8 | 3-3/4 | 1-15/16 | 1-3/32 | 1-15/16 | .21 |
| 4101-211 | 1-1/2X1-1/2X1 | 11/16 | 31/32 | 11/16 | 2 | 1-29/32 | 2 | 4 | 1-15/16 | 1-3/8 | 1-15/16 | .22 |
| 4101-212 ¹ | 1-1/2X1-1/2X1-1/4 | 29/32 | 1-3/8 | 29/32 | 2-1/4 | 2-1/2 | 2-1/4 | 4-1/2 | 1-15/16 | 1-15/16 | 1-15/16 | .34 |
| 4101-213 ¹ | 1-1/2X1-1/2X2 | 1-29/32 | 1-5/32 | 1-29/32 | 3-7/32 | 2-7/8 | 3-7/32 | 6-7/16 | 2-9/16 | 2-9/16 | 2-9/16 | .98 |
| 4101-216 ¹ | 2X1/2X1/2 | 1-5/32 | 2-5/8 | 2-5/8 | 2-7/8 | 3-5/32 | 3-5/32 | 6-1/32 | 2-9/16 | 2-9/16 | 2-9/16 | 1.01 |
| 4101-217 ¹ | 2X1/2X3/4 | 1-5/32 | 2-7/16 | 2-21/32 | 2-7/8 | 3-5/32 | 3-5/32 | 6-1/32 | 2-9/16 | 2-9/16 | 2-9/16 | 1.02 |
| 4101-218 ¹ | 2X1/2X1 | 1-5/32 | 2-9/32 | 2-5/8 | 2-7/8 | 3-7/32 | 3-5/32 | 6-1/32 | 2-9/16 | 2-9/16 | 2-9/16 | 1.03 |
| 4101-219 ¹ | 2X1/2X1-1/4 | 1-5/32 | 2-1/32 | 2-5/8 | 2-7/8 | 3-7/32 | 3-5/32 | 6-1/32 | 2-9/16 | 2-9/16 | 2-9/16 | 1.02 |
| 4101-220 ¹ | 2X1/2X1-1/2 | 1-5/32 | 1-29/32 | 2-5/8 | 2-7/8 | 3-7/32 | 3-5/32 | 6-1/32 | 2-9/16 | 2-9/16 | 2-9/16 | 1.00 |
| 4101-221 ¹ | 2X1/2X2 | 1-5/32 | 1-5/32 | 2-5/8 | 2-7/8 | 2-7/8 | 3-3/16 | 6-1/16 | 2-9/16 | 2-9/16 | 2-9/16 | .81 |
| 4101-222 ¹ | 2X3/4X1/2 | 1-5/32 | 2-21/32 | 2-7/16 | 2-7/8 | 3-3/16 | 3-3/16 | 6-1/16 | 2-9/16 | 2-9/16 | 2-9/16 | 1.02 |
| 4101-223 ¹ | 2X3/4X3/4 | 1-5/32 | 2-7/16 | 2-7/16 | 2-7/8 | 3-3/16 | 3-3/16 | 6-1/16 | 2-9/16 | 2-9/16 | 2-9/16 | 1.03 |
| 4101-224 ¹ | 2X3/4X1 | 1-3/16 | 2-5/16 | 2-7/16 | 2-7/8 | 3-7/32 | 3-3/16 | 6-1/16 | 2-9/16 | 2-9/16 | 2-9/16 | 1.04 |
| 4101-225 ¹ | 2X3/4X1-1/4 | 1-5/32 | 2-1/32 | 2-7/16 | 2-7/8 | 3-5/32 | 3-3/16 | 6-1/16 | 2-9/16 | 2-9/16 | 2-9/16 | 1.03 |

CTS CPVC Technical
CTS Product Dimensions



Tee - Reducing
 Socket x Socket x Socket
 NSF® Certified Lead Free

(Continued)

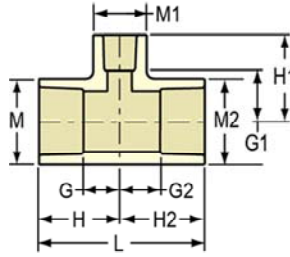

| Part Number | Size | G | G1 | G2 | H | H1 | H2 | L | M | M1 | M2 | Approx. Wt. (Lbs.) |
|-----------------------|---------------|---------|---------|---------|---------|---------|---------|---------|---------|---------|---------|--------------------|
| 4101-226 ¹ | 2X3/4X1-1/2 | 1-5/32 | 1-29/32 | 2- 7/16 | 2-7/8 | 3- 7/32 | 3-3/16 | 6-1/16 | 2- 9/16 | 2- 9/16 | 2- 9/16 | 1.01 |
| 4101-227 ¹ | 2X3/4X2 | 1-5/32 | 1- 5/32 | 2- 7/16 | 2-7/8 | 2- 7/8 | 3-3/16 | 6-1/16 | 2- 9/16 | 2- 9/16 | 2- 9/16 | .82 |
| 4101-228 ¹ | 2X1X1/2 | 1-5/32 | 2-21/32 | 2-9/32 | 2-7/8 | 3-5/32 | 3-7/32 | 6-3/32 | 2- 9/16 | 2- 9/16 | 2- 9/16 | 1.03 |
| 4101-229 ¹ | 2X1X3/4 | 1-5/32 | 2-7/16 | 2-9/32 | 2- 7/8 | 3- 3/16 | 3- 7/32 | 6- 3/32 | 2- 9/16 | 2- 9/16 | 2- 9/16 | 1.04 |
| 4101-230 ¹ | 2X1X1 | 1-5/32 | 2- 5/16 | 2-9/32 | 2-7/8 | 3- 7/32 | 3-7/32 | 6-3/32 | 2- 9/16 | 2- 9/16 | 2- 9/16 | 1.04 |
| 4101-231 ¹ | 2X1X1-1/4 | 1-5/32 | 2-1/16 | 2-9/32 | 2-7/8 | 3-3/16 | 3-7/32 | 6-3/32 | 2- 9/16 | 2- 9/16 | 2- 9/16 | 1.03 |
| 4101-232 ¹ | 2X1X1-1/2 | 1-5/32 | 1-29/32 | 2-9/32 | 2-7/8 | 3- 7/32 | 3-7/32 | 6-3/32 | 2- 9/16 | 2- 9/16 | 2- 9/16 | 1.01 |
| 4101-233 ¹ | 2X1X2 | 1-5/32 | 1- 5/32 | 2-9/32 | 2-7/8 | 2- 7/8 | 3- 5/32 | 6-3/32 | 2- 9/16 | 2- 9/16 | 2- 9/16 | .83 |
| 4101-234 ¹ | 2X1-1/4X1/2 | 1-5/32 | 2-21/32 | 2-1/32 | 2-7/8 | 3-5/32 | 3- 5/32 | 6-1/32 | 2- 9/16 | 2- 9/16 | 2- 9/16 | 1.02 |
| 4101-235 ¹ | 2X1-1/4X3/4 | 1-5/32 | 2-7/16 | 2-1/32 | 2-7/8 | 3-5/32 | 3- 5/32 | 6-1/32 | 2- 9/16 | 2- 9/16 | 2- 9/16 | 1.03 |
| 4101-236 ¹ | 2X1-1/4X1 | 1-5/32 | 2- 5/16 | 2-1/32 | 2-7/8 | 3-1/4 | 3- 5/32 | 6-1/32 | 2- 9/16 | 2- 9/16 | 2- 9/16 | 1.03 |
| 4101-237 ¹ | 2X1-1/2X1/2 | 1-5/32 | 2-5/8 | 1-29/32 | 2-7/8 | 3-5/32 | 3-7/32 | 6-3/32 | 2- 9/16 | 2- 9/16 | 2- 9/16 | 1.00 |
| 4101-238 ¹ | 2X1-1/2X3/4 | 1-5/32 | 2-15/32 | 1-29/32 | 2-7/8 | 3- 7/32 | 3-7/32 | 6-3/32 | 2- 9/16 | 2- 9/16 | 2- 9/16 | 1.01 |
| 4101-239 ¹ | 2X1-1/2X1 | 1-5/32 | 2-9/32 | 1-29/32 | 2-7/8 | 3- 7/32 | 3-7/32 | 6-3/32 | 2- 9/16 | 2- 9/16 | 2- 9/16 | 1.01 |
| 4101-240 ¹ | 2X1-1/2X1-1/4 | 1-5/16 | 2-1/32 | 1-29/32 | 2-7/8 | 3-5/32 | 3-7/32 | 6-3/32 | 2- 9/16 | 2- 9/16 | 2- 9/16 | 1.00 |
| 4101-241 ¹ | 2X1-1/2X1-1/2 | 1- 5/32 | 1-29/32 | 1-29/32 | 2- 7/8 | 3-7/32 | 3-7/32 | 6-3/32 | 2- 9/16 | 2- 9/16 | 2- 9/16 | .98 |
| 4101-242 ¹ | 2X1-1/4X1-1/4 | 1-5/32 | 2-1/32 | 2-1/32 | 2-7/8 | 3-5/32 | 3- 5/32 | 6-1/32 | 2- 9/16 | 2- 9/16 | 2- 9/16 | 1.02 |
| 4101-243 ¹ | 2X1-1/4X1-1/2 | 1-5/32 | 1-29/32 | 2-1/32 | 2-7/8 | 3- 7/32 | 3- 5/32 | 6-1/32 | 2- 9/16 | 2- 9/16 | 2- 9/16 | 1.00 |
| 4101-244 ¹ | 2X1-1/4X2 | 1- 5/32 | 1-5/32 | 2-1/32 | 2- 7/8 | 3- 7/32 | 3-5/32 | 6-1/32 | 2- 9/16 | 2- 9/16 | 2- 9/16 | .82 |
| 4101-247 | 2X2X1/2 | 13/32 | 1- 9/32 | 13/32 | 2- 1/8 | 1-25/32 | 2- 1/8 | 4-1/4 | 2- 9/16 | 27/32 | 2- 9/16 | .37 |
| 4101-248 | 2X2X3/4 | 17/32 | 1-9/32 | 17/32 | 2- 1/4 | 2 | 2- 1/4 | 4-1/2 | 2- 9/16 | 1- 1/8 | 2- 9/16 | .39 |
| 4101-249 | 2X2X1 | 11/16 | 1- 9/32 | 11/16 | 2-13/32 | 2- 3/16 | 2-13/32 | 4-13/16 | 2-9/16 | 1- 3/8 | 2-9/16 | .44 |
| 4101-250 ¹ | 2X2X1-1/4 | 13/16 | 1-1/4 | 13/16 | 2-17/32 | 2-3/8 | 2-17/32 | 5-1/16 | 2-17/32 | 1-11/16 | 2-17/32 | .82 |
| 4101-251 | 2X2X1-1/2 | 15/16 | 1- 1/4 | 15/16 | 2-21/32 | 2- 9/16 | 2-21/32 | 5-5/16 | 2-9/16 | 1-31/32 | 2-9/16 | .53 |
| 4101-257 ¹ | 2X1-1/2X2 | 1-5/32 | 1- 5/32 | 1-29/32 | 2-7/8 | 2- 7/8 | 3-7/32 | 6-3/32 | 2- 9/16 | 2- 9/16 | 2- 9/16 | .80 |

¹ Outlet sized with bushing.

Drop Ear Tee - CPVC Fitting with Bracket

Socket x Socket x Socket
 NSF® Certified Lead Free

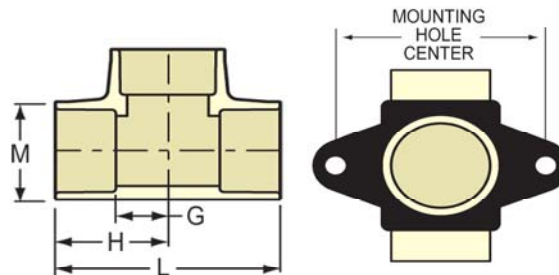

| Part Number | Size | G | H | L | M | Approx. Wt. (Lbs.) |
|-------------|------|-------|-------|--------|-------|--------------------|
| DE4101-005 | 1/2 | 13/32 | 15/16 | 1- 7/8 | 27/32 | .03 |



CTS CPVC Technical
CTS Product Dimensions

90° EII

Socket x Socket
 NSF® Certified Lead Free

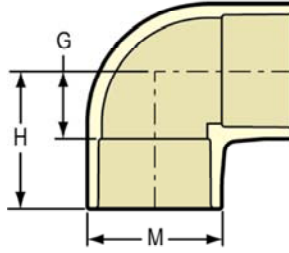

| Part Number | Size | G | H | M | Approx. Wt. (Lbs.) |
|-------------|-------|--------|---------|---------|--------------------|
| 4106-005 | 1/2 | 13/32 | 15/16 | 27/32 | .02 |
| 4106-007 | 3/4 | 17/32 | 1- 1/4 | 1- 1/8 | .04 |
| 4106-010 | 1 | 21/32 | 1- 9/16 | 1- 3/8 | .07 |
| 4106-012 | 1-1/4 | 25/32 | 1- 7/8 | 1-21/32 | .12 |
| 4106-015 | 1-1/2 | 29/32 | 2-1/4 | 1-31/32 | .21 |
| 4106-020 | 2 | 1-3/16 | 2- 7/8 | 2-9/16 | .46 |

90° EII - Reducing

Socket x Socket
 NSF® Certified Lead Free

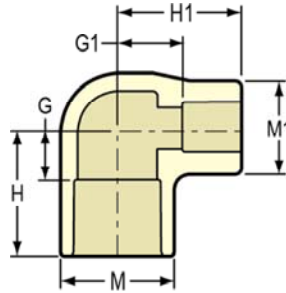

| Part Number | Size | G | G1 | H | H1 | M | M1 | Approx. Wt. (Lbs.) |
|-----------------------|-------------|--------|---------|---------|---------|---------|---------|--------------------|
| 4106-101 | 3/4X1/2 | 3/8 | 1/2 | 1-1/8 | 1- 1/32 | 1- 3/32 | 27/32 | .03 |
| 4106-130 ¹ | 1X1/2 | 21/32 | 1-9/32 | 1-9/16 | 1-13/16 | 1-3/8 | 1-3/8 | .11 |
| 4106-131 ¹ | 1X3/4 | 21/32 | 31/32 | 1- 9/16 | 1-11/16 | 1- 3/8 | 1- 3/8 | .10 |
| 4106-167 ¹ | 1-1/4X3/4 | 25/32 | 1-7/16 | 1-29/32 | 2-5/32 | 1-21/32 | 1-21/32 | .19 |
| 4106-168 ¹ | 1-1/4X1 | 25/32 | 1-3/16 | 1-29/32 | 2-3/32 | 1-21/32 | 1-21/32 | .17 |
| 4106-209 ¹ | 1-1/2X1/2 | 29/32 | 2- 1/32 | 2- 1/4 | 2-9/16 | 1-15/16 | 1-15/16 | .32 |
| 4106-210 ¹ | 1-1/2X3/4 | 29/32 | 1-27/32 | 2- 1/4 | 2- 9/16 | 1-15/16 | 1-15/16 | .31 |
| 4106-211 ¹ | 1-1/2X1 | 29/32 | 1-9/16 | 2- 1/4 | 2-1/2 | 1-15/16 | 1-15/16 | .31 |
| 4106-212 ¹ | 1-1/2X1-1/4 | 29/32 | 1-3/8 | 2- 1/4 | 2-1/2 | 1-15/16 | 1-15/16 | .27 |
| 4106-247 ¹ | 2X1/2 | 1-5/32 | 2-5/8 | 2-7/8 | 3- 3/16 | 2- 9/16 | 2- 9/16 | .66 |
| 4106-248 ¹ | 2X3/4 | 1-5/32 | 2- 7/16 | 2-7/8 | 3- 5/32 | 2- 9/16 | 2- 9/16 | .67 |
| 4106-249 ¹ | 2X1 | 1-5/32 | 2- 9/32 | 2-7/8 | 3- 3/16 | 2- 9/16 | 2- 9/16 | .68 |
| 4106-250 ¹ | 2X1-1/4 | 1-5/32 | 2-1/32 | 2-7/8 | 3- 5/32 | 2- 9/16 | 2- 9/16 | .66 |
| 4106-251 ¹ | 2X1-1/2 | 1-5/32 | 1-7/8 | 2-7/8 | 3- 7/32 | 2- 9/16 | 2- 9/16 | .64 |

¹ Outlet sized with bushing.

CTS CPVC Technical
CTS Product Dimensions



90° EII - Special Reinforced

Socket x SR Fipt - Stainless Steel Collar
 NSF® Certified Lead Free

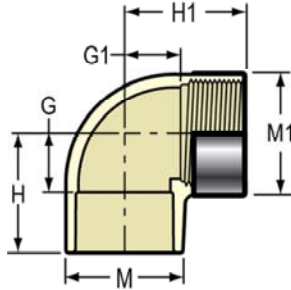

| Part Number | Size | G | G1 | H | H1 | M | M1 | Approx. Wt. (Lbs.) |
|-------------|------|-------|-----|-------|-------|-------|---------|--------------------|
| 4107-005SR | 1/2 | 13/32 | 3/8 | 15/16 | 1-1/8 | 27/32 | 1- 7/32 | .05 |

Drop Ear 90° EII - CPVC Zinc Reinforced (One Piece Unit)

Socket x SR Fipt - Zinc Collar
 NSF® Certified Lead Free

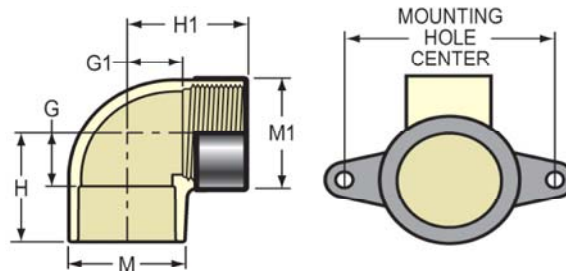

| Part Number | Size | G | G1 | H | H1 | M | M1 | Approx. Wt. (Lbs.) |
|---------------|------|-------|-------|-------|--------|-------|-------|--------------------|
| DEZ4107-005SR | 1/2 | 13/32 | 13/32 | 15/16 | 1-7/32 | 27/32 | 1-3/8 | .15 |

Drop Ear 90° EII - CPVC Fitting with Bracket

Socket x Socket
 NSF® Certified Lead Free

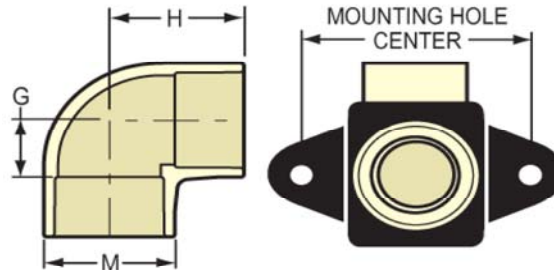

| Part Number | Size | G | H | M | Approx. Wt. (Lbs.) |
|-------------|------|-------|-------|-------|--------------------|
| DE4106-005 | 1/2 | 13/32 | 15/16 | 27/32 | .03 |

Drop Ear 90° EII - Special Reinforced CPVC Fitting with Bracket

Socket x SR Fipt - Stainless Steel Collar
 NSF® Certified Lead Free

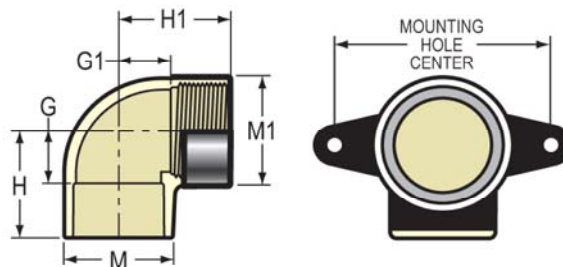

| Part Number | Size | G | G1 | H | H1 | M | M1 | Mounting Hole Center | Approx. Wt. (Lbs.) |
|--------------|------|------|-----|-------|---------|-------|---------|----------------------|--------------------|
| DE4107-005SR | 1/2 | 7/16 | 3/8 | 15/16 | 1- 5/32 | 27/32 | 1- 7/32 | 2-1/32 | .06 |



CTS CPVC Technical
CTS Product Dimensions

Drop Ear EII - CPVC One Piece

Socket x Socket
 NSF® Certified Lead Free

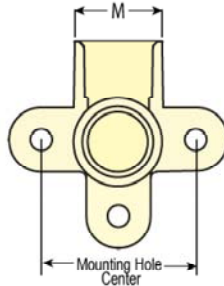

| Part Number | Size | M | Approx. Wt. (Lbs.) |
|-------------|------|-------|--------------------|
| DE4106-005C | 1/2 | 13/16 | .04 |

Drop Ear EII - CPVC One Piece with Gasket

Socket x Fipt
 NSF® Certified Lead Free

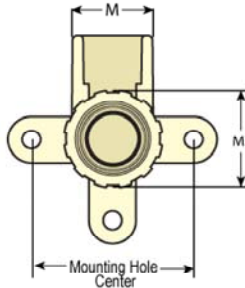

| Part Number | Size | M | M1 | Approx. Wt. (Lbs.) |
|--------------|------|-----|--------|--------------------|
| DE4107-005CG | 1/2 | 7/8 | 1-3/16 | .07 |

Drop Ear EII - Stainless Steel Thread

Socket x SS Fipt
 NSF® Certified Lead Free

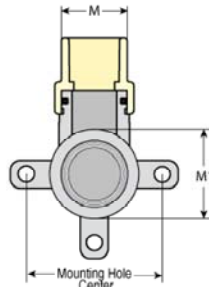

| Part Number | Size | M | M1 | Approx. Wt. (Lbs.) |
|--------------|------|-------|--------|--------------------|
| DE4107-005SS | 1/2 | 27/32 | 1-3/16 | .23 |

Drop Ear EII - Stainless Steel Thread/CPVC Body

Socket x SS Fipt
 NSF® Certified Lead Free

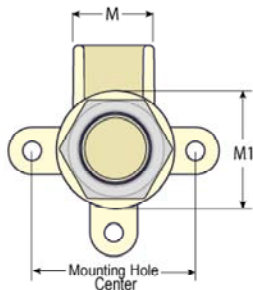

| Part Number | Size | M | M1 | Mounting Hole Center | Approx. Wt. (Lbs.) |
|---------------|------|-----|--------|----------------------|--------------------|
| DE4107-005CSS | 1/2 | 7/8 | 1-3/16 | 1-3/4 | .37 |

CTS CPVC Technical
CTS Product Dimensions



90° Street Ell

Spigot x Socket
 NSF® Certified Lead Free

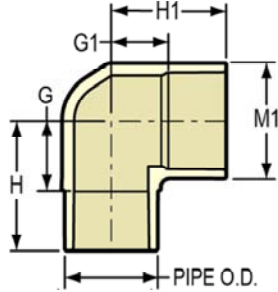

| Part Number | Size | G | G1 | H | H1 | M1 | Pipe O.D. | Approx. Wt. (Lbs.) |
|-------------|------|-------|-------|---------|---------|---------|-----------|--------------------|
| 4109-005 | 1/2 | 17/32 | 3/8 | 1- 1/16 | 7/8 | 27/32 | 5/8 | .02 |
| 4109-007 | 3/4 | 19/32 | 17/32 | 1- 5/16 | 1- 1/4 | 1-1/8 | 7/8 | .04 |
| 4109-010 | 1 | 25/32 | 21/32 | 1-11/16 | 1- 9/16 | 1-11/32 | 1-1/8 | .09 |

90° Stub Out Ell

Socket x Closed End
 NSF® Certified Lead Free

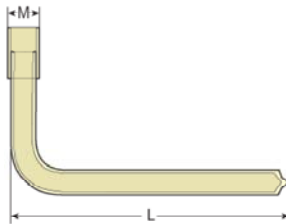

| Part Number | Size | L | M | Approx. Wt. (Lbs.) |
|-------------|------|----|-------|--------------------|
| S4106-005 | 1/2 | 29 | 27/32 | .09 |

90° Stub Out Elbow

Socket X Open End
 NSF® Certified Lead Free

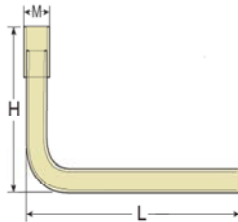

| Part Number | Size | H | L | M | Approx. Wt. (Lbs.) |
|-------------|------|--------|----|--------|--------------------|
| S4109-005 | 1/2 | 9-3/4 | 29 | 27/32 | .25 |
| S4109-007 | 3/4 | 10-1/4 | 29 | 1-3/32 | .46 |



CTS CPVC Technical
CTS Product Dimensions

45° EII

Socket x Socket
 NSF® Certified Lead Free

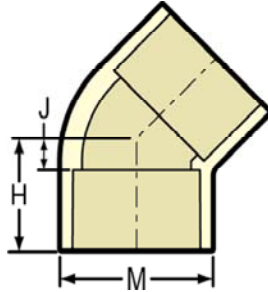

| Part Number | Size | H | J | M | Approx. Wt. (Lbs.) |
|-------------|-------|---------|-------|---------|--------------------|
| 4117-005 | 1/2 | 23/32 | 7/32 | 27/32 | .01 |
| 4117-007 | 3/4 | 31/32 | 1/4 | 1-3/32 | .03 |
| 4117-010 | 1 | 1- 7/32 | 5/16 | 1- 3/8 | .05 |
| 4117-012 | 1-1/4 | 1-15/32 | 11/32 | 1-21/32 | .11 |
| 4117-015 | 1-1/2 | 1-23/32 | 13/32 | 1-31/32 | .17 |
| 4117-020 | 2 | 2-7/32 | 1/2 | 2- 9/16 | .37 |

45° Street EII

Spigot x Socket
 NSF® Certified Lead Free

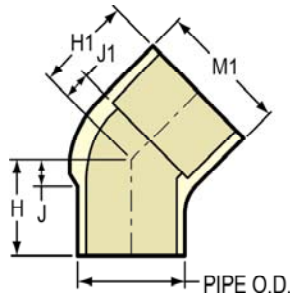

| Part Number | Size | H | H1 | J | J1 | M1 | Approx. Wt. (Lbs.) |
|-------------|------|---------|--------|-------|------|---------|--------------------|
| 4127-005 | 1/2 | 3/4 | 23/32 | 1/4 | 7/32 | 27/32 | .01 |
| 4127-007 | 3/4 | 1-1/32 | 31/32 | 5/16 | 1/4 | 1- 3/32 | .03 |
| 4127-010 | 1 | 1- 5/16 | 1-7/32 | 13/32 | 5/16 | 1- 3/8 | .05 |

Coupling

Socket x Socket
 NSF® Certified Lead Free

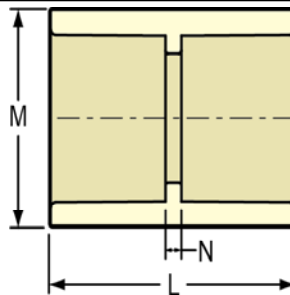

| Part Number | Size | L | M | N | Approx. Wt. (Lbs.) |
|-------------|-------|---------|---------|-----|--------------------|
| 4129-005 | 1/2 | 1- 5/32 | 27/32 | 1/8 | .01 |
| 4129-007 | 3/4 | 1- 9/16 | 1-3/32 | 1/8 | .02 |
| 4129-010 | 1 | 1-15/16 | 1- 3/8 | 1/8 | .04 |
| 4129-012 | 1-1/4 | 2- 3/8 | 1-21/32 | 1/8 | .08 |
| 4129-015 | 1-1/2 | 2- 3/4 | 1-31/32 | 1/8 | .13 |
| 4129-020 | 2 | 3- 9/16 | 2- 9/16 | 1/8 | .28 |

CTS CPVC Technical
CTS Product Dimensions



Coupling - Reducer

Socket x Socket
 NSF® Certified Lead Free

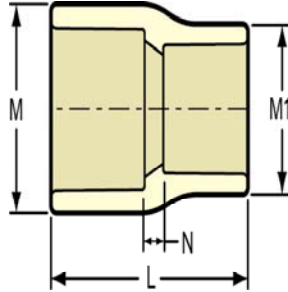

| Part Number | Size | L | M | M1 | N | Approx. Wt. (Lbs.) |
|-----------------------|-------------|---------|---------|---------|---------|--------------------|
| 4129-101 | 3/4X1/2 | 1-11/32 | 1- 3/32 | 13/16 | 1/8 | .02 |
| 4129-130 | 1X1/2 | 2-5/32 | 1-3/8 | 1-3/8 | 23/32 | .08 |
| 4129-131 | 1X3/4 | 1- 3/4 | 1-11/32 | 1- 3/32 | 1/8 | .03 |
| 4129-166 ¹ | 1-1/4X1/2 | 2- 5/8 | 1-21/32 | 1-21/32 | 31/32 | .14 |
| 4129-167 ¹ | 1-1/4X3/4 | 2- 5/8 | 1-21/32 | 1-21/32 | 25/32 | .14 |
| 4129-168 ¹ | 1-1/4X1 | 2-9/16 | 1-21/32 | 1-21/32 | 1/2 | .12 |
| 4129-209 ¹ | 1-1/2X1/2 | 3- 1/16 | 1-31/32 | 1-31/32 | 1-1/4 | .23 |
| 4129-210 ¹ | 1-1/2X3/4 | 3- 1/16 | 1-15/16 | 1-15/16 | 1- 1/32 | .23 |
| 4129-211 ¹ | 1-1/2X1 | 3 | 2 | 2 | 3/4 | .22 |
| 4129-212 ¹ | 1-1/2X1-1/4 | 3 | 1-15/16 | 1-15/16 | 9/16 | .19 |
| 4129-247 ¹ | 2X1/2 | 3-3/4 | 2-11/16 | 2-11/16 | 1-1/2 | .48 |
| 4129-248 ¹ | 2X3/4 | 3-27/32 | 2-17/32 | 2-17/32 | 1-3/8 | .49 |
| 4129-249 | 2X1 | 3-7/8 | 2- 9/16 | 2- 9/16 | 1-1/4 | .50 |
| 4129-250 ¹ | 2X1-1/4 | 3-13/16 | 2- 9/16 | 2- 9/16 | 1 | .48 |
| 4129-251 ¹ | 2X1-1/2 | 3-23/32 | 2- 9/16 | 2- 9/16 | 11/16 | .46 |

¹ Outlet sized with bushing.

GripLoc™ Coupling

WARNING: DO NOT INSERT FINGERS
 Grip Socket x Grip Socket - Uses No Solvent Cement
 NSF® Certified Lead Free

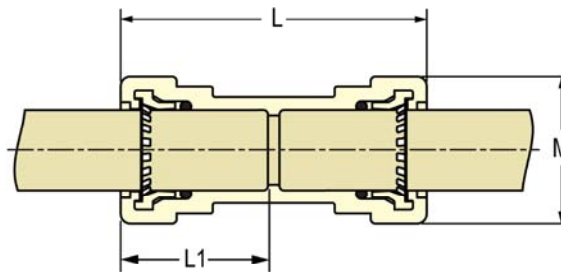

| Part Number | Size | L | L1 | M | Approx. Wt. (Lbs.) |
|-------------|------|--------|---------|---------|--------------------|
| GL4129-005 | 1/2 | 2-3/4 | 1-5/16 | 1-1/4 | .10 |
| GL4129-007 | 3/4 | 3-5/16 | 1-9/32 | 1-17/32 | .15 |
| GL4129-010 | 1 | 4 | 1-29/32 | 2 | .26 |

Note: The GripLoc™ is water tight, permanent and cannot be removed.



CTS CPVC Technical
CTS Product Dimensions

Female Adapter - with Gasket

Socket x Thread
 For Cold Water Service Only - NSF® Certified
 Lead Free

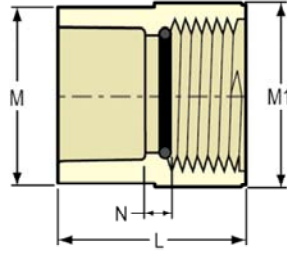

| Part Number | Size | L | M | M1 | N | Approx. Wt. (Lbs.) |
|-------------|------|---------|-------|---------|-------|--------------------|
| 4135-005OR | 1/2 | 1-1/4 | 27/32 | 1- 7/32 | 11/32 | .02 |
| 4135-007OR | 3/4 | 1-1/2 | 1-1/8 | 1-1/2 | 11/32 | .04 |
| 4135-010OR | 1 | 1-15/16 | 1-3/8 | 1-7/8 | 11/32 | .09 |

Female Adapter - Gasket Sealed Brass Thread Transition

Socket x Gasket Fipt - Use NO Thread Sealant
 NSF® Certified Lead Free

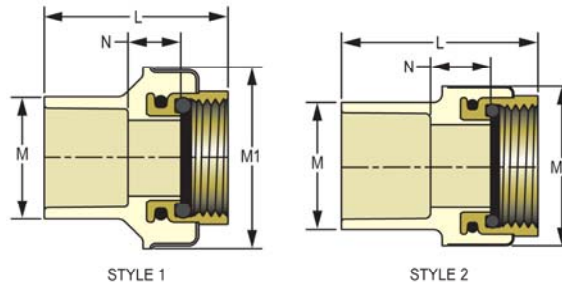

| Part Number | Size | L | M | M1 | N | Style | Approx. Wt. (Lbs.) |
|-------------|-------|---------|---------|---------|-------|-------|--------------------|
| 4135-005BRG | 1/2 | 1- 1/2 | 27/32 | 1- 7/16 | 9/16 | 1 | .11 |
| 4135-007BRG | 3/4 | 1- 9/16 | 1- 3/32 | 1- 5/8 | 15/32 | 1 | .20 |
| 4135-010BRG | 1 | 2- 1/32 | 1-11/32 | 1-23/32 | 5/8 | 2 | .21 |
| 4135-012BRG | 1-1/4 | 2- 7/32 | 1-21/32 | 2- 1/16 | 19/32 | 2 | .31 |
| 4135-015BRG | 1-1/2 | 2- 7/16 | 1-15/16 | 2- 7/16 | 5/8 | 2 | .42 |
| 4135-020BRG | 2 | 2-27/32 | 2-17/32 | 3 | 19/32 | 2 | .55 |

Female Adapter - Reducing Gasket Sealed Brass Thread Transition

Socket x Gasket Fipt - Use NO Thread Sealant
 NSF® Certified Lead Free

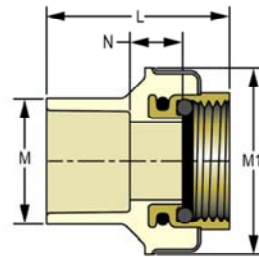

| Part Number | Size | L | M | M1 | N | Approx. Wt. (Lbs.) |
|-------------|---------|---------|---------|---------|-------|--------------------|
| 4135-101BRG | 3/4X1/2 | 1- 9/16 | 1- 3/32 | 1- 7/16 | 7/16 | .11 |
| 4135-130BRG | 1X1/2 | 1- 3/4 | 1-11/32 | 1- 7/16 | 13/32 | .12 |

CTS CPVC Technical
CTS Product Dimensions



Female Adapter - CPVC Special Reinforced

Socket x SR Fipt - Stainless Steel Collar
 NSF® Certified Lead Free

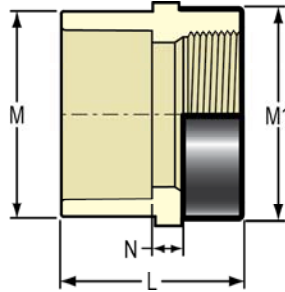

| Part Number | Size | L | M | M1 | N | Approx. Wt. (Lbs.) |
|-------------|------|---------|---------|---------|-----|--------------------|
| 4135-005SR | 1/2 | 1- 3/8 | 27/32 | 1- 7/32 | 1/8 | .04 |
| 4135-007SR | 3/4 | 1-9/16 | 1- 3/32 | 1- 3/8 | 1/8 | .06 |
| 4135-010SR | 1 | 1-15/16 | 1- 3/8 | 1-23/32 | 1/8 | .10 |

Female Adapter - CPVC Reducing Special Reinforced

Socket x SR Fipt - Stainless Steel Collar
 NSF® Certified Lead Free

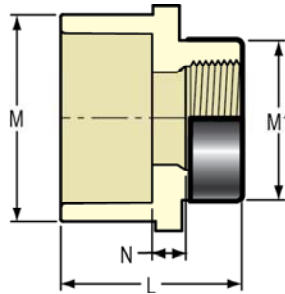

| Part Number | Size | L | M | M1 | N | Approx. Wt. (Lbs.) |
|-------------|-------|-------|---------|--------|------|--------------------|
| 4135-131SR | 1X3/4 | 1-7/8 | 1-13/32 | 1- 3/8 | 3/16 | .07 |

Female Adapter - Stainless Steel Thread Transition

Socket x SS Fipt
 NSF® Certified Lead Free

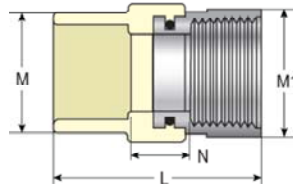

| Part Number | Size | L | M | M1 | N | Approx. Wt. (Lbs.) |
|-------------|-------|---------|---------|---------|-------|--------------------|
| 4135-005SS | 1/2 | 1-3/4 | 7/8 | 1-1/32 | 19/32 | .10 |
| 4135-007SS | 3/4 | 2 | 1-3/32 | 1-5/16 | 21/32 | .18 |
| 4135-010SS | 1 | 2-11/32 | 1-3/8 | 1-21/32 | 5/8 | .28 |
| 4135-012SS | 1-1/4 | 2-15/16 | 1-11/16 | 2-3/16 | 7/8 | .69 |
| 4135-015SS | 1-1/2 | 3-5/32 | 1-31/32 | 2-7/16 | 7/8 | .81 |
| 4135-020SS | 2 | 3-21/32 | 2-9/16 | 3 | 15/16 | 1.45 |



CTS CPVC Technical
CTS Product Dimensions

Male Adapter

Mipt x Socket
 For Cold Water Service Only - NSF® Certified
 Lead Free

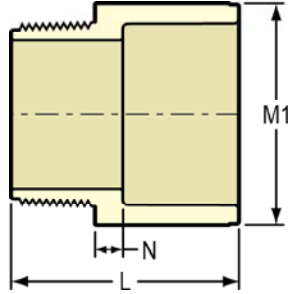

| Part Number | Size | L | M1 | N | Approx. Wt. (Lbs.) |
|-------------|-------|---------|---------|------|--------------------|
| 4136-005 | 1/2 | 1- 9/32 | 27/32 | 5/32 | .01 |
| 4136-007 | 3/4 | 1-17/32 | 1-3/16 | 1/8 | .02 |
| 4136-010 | 1 | 1- 7/8 | 1-11/32 | 3/32 | .05 |
| 4136-012 | 1-1/4 | 2- 9/32 | 1-11/16 | 5/16 | .09 |
| 4136-015 | 1-1/2 | 2-17/32 | 1-15/16 | 5/16 | .13 |
| 4136-020 | 2 | 2-31/32 | 2-9/16 | 5/16 | .23 |

Male Adapter - Reducing

Mipt x Socket
 For Cold Water Service Only - NSF® Certified
 Lead Free

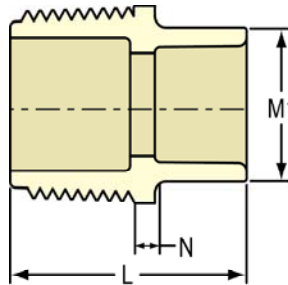

| Part Number | Size | L | M1 | N | Approx. Wt. (Lbs.) |
|-------------|---------|---------|---------|------|--------------------|
| 4136-074 | 1/2X3/4 | 1-9/16 | 1- 3/32 | 5/32 | .02 |
| 4136-101 | 3/4X1/2 | 1-11/32 | 27/32 | 1/8 | .02 |

Male Adapter - Spigot

Mipt x Spigot
 For Cold Water Service Only - NSF® Certified
 Lead Free

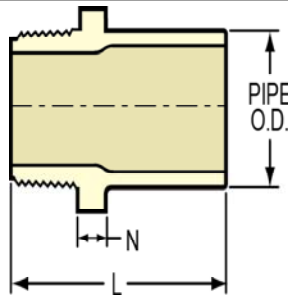

| Part Number | Size | L | N | Pipe O.D. | Approx. Wt. (Lbs.) |
|-------------|------|---------|------|-----------|--------------------|
| 4161-005 | 1/2 | 1- 5/16 | 3/16 | 5/8 | .01 |

CTS CPVC Technical
CTS Product Dimensions



**Male Adapter - Internal
 Stainless Steel Reinforced**

R Mipt x Socket
 NSF® Certified Lead Free

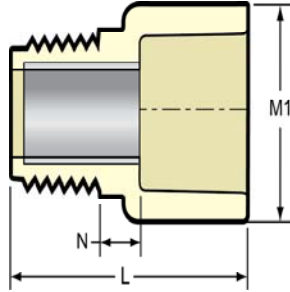

| Part Number | Size | L | M1 | N | Approx. Wt. (Lbs.) |
|-------------|-------|---------|---------|-------|--------------------|
| 4136-005R | 1/2 | 1-23/32 | 27/32 | 9/16 | .03 |
| 4136-007R | 3/4 | 1-15/16 | 1- 3/32 | 9/16 | .05 |
| 4136-010R | 1 | 2- 7/16 | 1-11/32 | 11/16 | .11 |
| 4136-012R | 1-1/4 | 2-13/16 | 1-11/16 | 11/16 | .13 |
| 4136-015R | 1-1/2 | 3-3/32 | 1-31/32 | 3/4 | .18 |
| 4136-020R | 2 | 3-9/16 | 2-9/16 | 3/4 | .27 |



**Male Adapter - Transition with
 CPVC Lined Brass Thread**

Brass Mipt x Socket
 NSF® Certified Lead Free

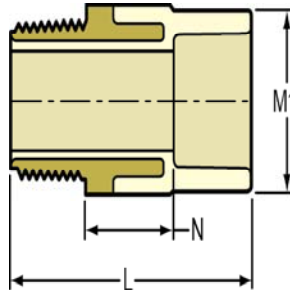

| Part Number | Size | L | M1 | N | Approx. Wt. (Lbs.) |
|-------------|-------|---------|---------|-------|--------------------|
| 4136-005BR | 1/2 | 2 | 27/32 | 25/32 | .14 |
| 4136-007BR | 3/4 | 2- 1/4 | 1- 3/16 | 27/32 | .21 |
| 4136-010BR | 1 | 2-11/16 | 1- 3/8 | 29/32 | .37 |
| 4136-012BR | 1-1/4 | 3 | 1-21/32 | 31/32 | .61 |
| 4136-015BR | 1-1/2 | 3-7/32 | 1-15/16 | 31/32 | .74 |
| 4136-020BR | 2 | 3-5/8 | 2-17/32 | 31/32 | 1.06 |



CTS CPVC Technical
CTS Product Dimensions

Male Adapter - Transition with Stainless Steel Thread

Socket x SS Mipt
 NSF® Certified Lead Free

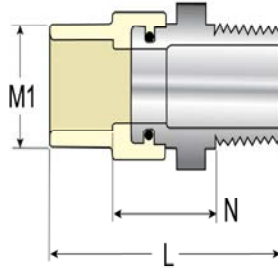

| Part Number | Size | L | M1 | N | Approx. Wt. (Lbs.) |
|-------------|-------|---------|---------|--------|--------------------|
| 4136-005SS | 1/2 | 1-31/32 | 7/8 | 3/4 | .15 |
| 4136-007SS | 3/4 | 2-3/16 | 1-3/32 | 3/4 | .17 |
| 4136-010SS | 1 | 2-27/32 | 1-3/8 | 1 | .31 |
| 4136-012SS | 1-1/4 | 3-9/32 | 1-11/16 | 1-1/4 | .57 |
| 4136-015SS | 1-1/2 | 3-17/32 | 2 | 1-1/4 | .86 |
| 4136-020SS | 2 | 3-31/32 | 2-9/16 | 1-5/16 | 1.08 |

Reducer Bushing

Spigot x Socket
 NSF® Certified Lead Free

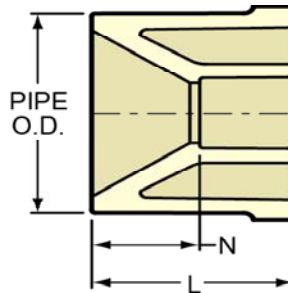

| Part Number | Size | L | N | Pipe O.D. | Approx. Wt. (Lbs.) |
|-------------|-------------|---------|---------|-----------|--------------------|
| 4137-101 | 3/4X1/2 | 27/32 | 1/8 | 7/8 | .01 |
| 4137-130 | 1X1/2 | 1- 1/8 | 5/8 | 1-1/8 | .03 |
| 4137-131 | 1X3/4 | 1- 1/16 | 11/32 | 1-1/8 | .02 |
| 4137-166 | 1-1/4X1/2 | 1-3/8 | 7/8 | 1-3/8 | .06 |
| 4137-167 | 1-1/4X3/4 | 1- 3/8 | 21/32 | 1-3/8 | .06 |
| 4137-168 | 1-1/4X1 | 1- 5/16 | 3/8 | 1-3/8 | .04 |
| 4137-209 | 1-1/2X1/2 | 1-21/32 | 1- 1/8 | 1-5/8 | .10 |
| 4137-210 | 1-1/2X3/4 | 1- 5/8 | 29/32 | 1-5/8 | .09 |
| 4137-211 | 1-1/2X1 | 1-19/32 | 21/32 | 1-5/8 | .09 |
| 4137-212 | 1-1/2X1-1/4 | 1-19/32 | 7/16 | 1-5/8 | .05 |
| 4137-247 | 2X1/2 | 1-29/32 | 1-3/8 | 2-1/8 | .20 |
| 4137-248 | 2X3/4 | 2 | 1- 9/32 | 2-1/8 | .20 |
| 4137-249 | 2X1 | 2-1/16 | 1-1/8 | 2-1/8 | .21 |
| 4137-250 | 2X1-1/4 | 1-31/32 | 7/8 | 2-1/8 | .20 |
| 4137-251 | 2X1-1/2 | 2- 1/32 | 23/32 | 2-1/8 | .18 |

CTS CPVC Technical
CTS Product Dimensions



Transition Bushing

IPS Spigot x CTS Socket
 NSF® Certified Lead Free

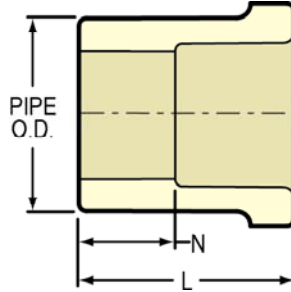

| Part Number | Size | L | N | Pipe O.D. | Approx. Wt. (Lbs.) |
|-------------|-------|---------|-------|-----------|--------------------|
| 4140-005 | 1/2 | 15/16 | 13/32 | 27/32 | .01 |
| 4140-007 | 3/4 | 1-5/32 | 7/16 | 1-1/16 | .01 |
| 4140-010 | 1 | 1-9/32 | 11/32 | 1-5/16 | .03 |
| 4140-012 | 1-1/4 | 1-7/16 | 11/32 | 1-21/32 | .06 |
| 4140-015 | 1-1/2 | 1-21/32 | 5/16 | 1-29/32 | .07 |
| 4140-020 | 2 | 1-27/32 | 1/8 | 2-3/8 | .10 |

Transition Coupling

IPS Socket x CTS Socket
 NSF® Certified Lead Free

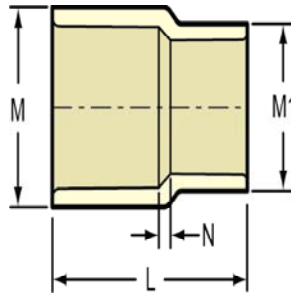

| Part Number | Size | L | M | M1 | N | Approx. Wt. (Lbs.) |
|-------------|------|---------|---------|---------|-----|--------------------|
| 4141-007 | 3/4 | 1-27/32 | 1- 5/16 | 1- 3/32 | 1/8 | .04 |
| 4141-010 | 1 | 2- 5/32 | 1-19/32 | 1- 3/8 | 1/8 | .07 |

Cap

Socket
 NSF® Certified Lead Free

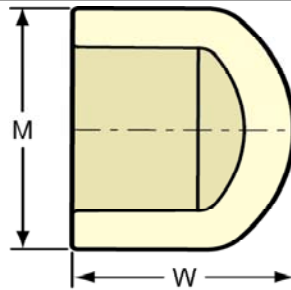

| Part Number | Size | M | W | Approx. Wt. (Lbs.) |
|-------------|-------|---------|---------|--------------------|
| 4147-005 | 1/2 | 27/32 | 21/32 | .01 |
| 4147-007 | 3/4 | 1-3/32 | 7/8 | .02 |
| 4147-010 | 1 | 1- 3/8 | 1- 9/32 | .03 |
| 4147-012 | 1-1/4 | 1-21/32 | 1-9/16 | .06 |
| 4147-015 | 1-1/2 | 1-15/16 | 1-7/8 | .10 |
| 4147-020 | 2 | 2- 9/16 | 2-7/16 | .22 |



CTS CPVC Technical
CTS Product Dimensions

GripLoc™ Cap

WARNING: DO NOT INSERT FINGERS
 Grip Socket - Uses No Solvent Cement
 NSF® Certified Lead Free

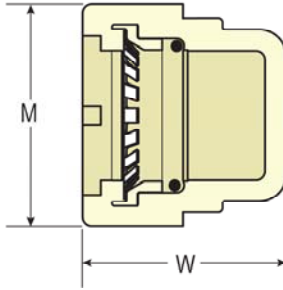

| Part Number | Size | M | W | Approx. Wt. (Lbs.) |
|-------------|------|--------|---------|--------------------|
| GL4147-005 | 1/2 | 1-5/16 | 1-1/4 | .04 |
| GL4147-007 | 3/4 | 1-7/16 | 1-17/32 | .06 |
| GL4147-010 | 1 | 1-3/4 | 2 | .12 |

Note: The GripLoc™ is water tight, permanent and cannot be removed.

Union

Socket with EPDM O-ring Seal
 100 psi Maximum Internal Pressure @ 180°F
 (82°C) - NSF® Certified Lead Free

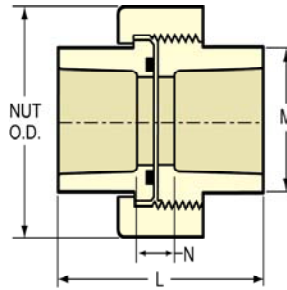

| Part Number | Size | L | M | N | NUT O.D. | Approx. Wt. (Lbs.) |
|-------------|-------|---------|---------|------|----------|--------------------|
| 4197-005 | 1/2 | 1-3/8 | 27/32 | 5/16 | 1-7/16 | .05 |
| 4197-007 | 3/4 | 1-3/4 | 1-1/16 | 5/16 | 1-23/32 | .07 |
| 4197-010 | 1 | 2-13/32 | 1-1/2 | 9/16 | 2-1/2 | .28 |
| 4197-012 | 1-1/4 | 2-21/32 | 1-23/32 | 3/8 | 2-21/32 | .25 |
| 4197-015 | 1-1/2 | 2-15/16 | 2-1/16 | 5/16 | 3-3/16 | .41 |
| 4197-020 | 2 | 3-31/32 | 2-9/16 | 1/2 | 3-5/8 | .58 |

Union - Special Reinforced

Socket x SR Fipt - Stainless Steel Collar
 100 psi Maximum Internal Pressure @ 180°F
 (82°C) - NSF® Certified Lead Free

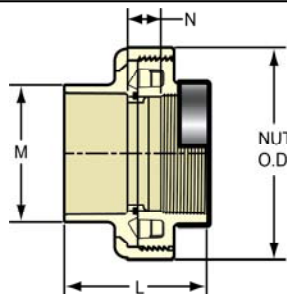

| Part Number | Size | L | M | N | NUT O.D. | Approx. Wt. (Lbs.) |
|-------------|------|---------|--------|-------|----------|--------------------|
| 4199-005SR | 1/2 | 1-9/16 | 27/32 | 5/16 | 1-15/16 | .12 |
| 4199-007SR | 3/4 | 1-13/16 | 1-3/32 | 13/32 | 2-3/8 | .19 |
| 4199-010SR | 1 | 2-1/4 | 1-3/8 | 7/16 | 2-21/32 | .27 |

CTS CPVC Technical
CTS Product Dimensions



**Union - Gasket Sealed Brass
 Thread Transition**

Socket x Gasket Fipt
 - Use No Thread Sealant
 100 psi Maximum Internal Pressure @ 180°F
 (82°C) - NSF® Certified Lead Free

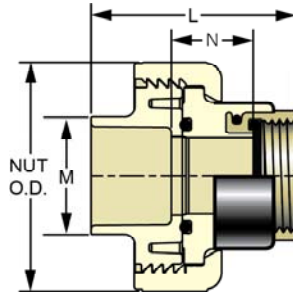

| Part Number | Size | L | M | N | NUT O.D. | Approx. Wt. (Lbs.) |
|-------------|------|---------|---------|-------|----------|--------------------|
| 4199-005BRG | 1/2 | 1-11/16 | 27/32 | 3/4 | 2- 1/8 | .22 |
| 4199-007BRG | 3/4 | 1-29/32 | 1- 3/32 | 25/32 | 2-11/32 | .34 |
| 4199-010BRG | 1 | 2- 3/8 | 1- 3/8 | 15/16 | 2-21/32 | .40 |

**Transition Compression
 Adapter**

Compression w/Gasket x CPVC Spigot
 NSF® Certified Lead Free

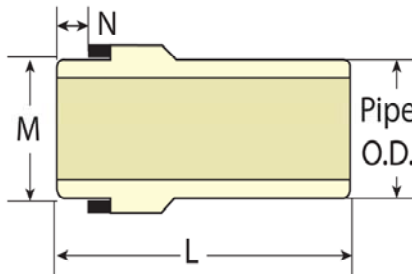

| Part Number | Size | L | M | N | Approx. Wt. (Lbs.) |
|-------------|------|--------|-----|------|--------------------|
| TCA-005 | 1/2 | 1-1/2 | 5/8 | 9/32 | .01 |
| TCA-007 | 3/4 | 2-3/32 | 7/8 | 3/8 | .02 |



**Transition Union - Brass
 Compression**

Brass Compression x CPVC Spigot
 NSF® Certified Lead Free

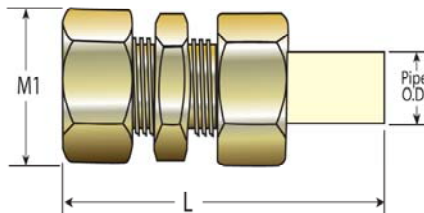

| Part Number | Size | L | M1 | Approx. Wt. (Lbs.) |
|-------------|------|---------|--------|--------------------|
| TUC-005 | 1/2 | 2-21/32 | 1 | .15 |
| TUC-007 | 3/4 | 3-5/16 | 1-7/16 | .34 |



CTS CPVC Technical
CTS Product Dimensions

Transition Union - Brass Male Thread

Brass Mipt x CPVC Spigot
 NSF® Certified Lead Free

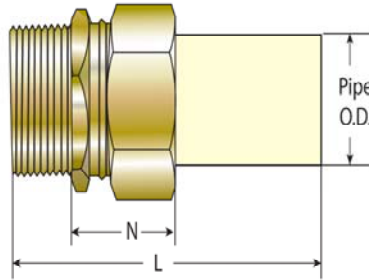

| Part Number | Size | L | N | Approx. Wt. (Lbs.) |
|-------------|------|---------|--------|--------------------|
| TUM-005 | 1/2 | 2-7/16 | 1 | .12 |
| TUM-007 | 3/4 | 2-31/32 | 1-7/16 | .22 |

Transition Union - Brass Female Thread

Brass Fipt x CPVC Spigot
 NSF® Certified Lead Free

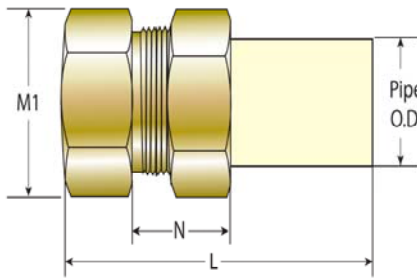

| Part Number | Size | L | M1 | N | Approx. Wt. (Lbs.) |
|-------------|------|-------|---------|-------|--------------------|
| TUF-005 | 1/2 | 2-3/8 | 1-1/8 | 7/8 | .15 |
| TUF-007 | 3/4 | 3 | 1-13/32 | 29/32 | .29 |



CPVC-PEX Transition Spigot Adapters

Spigot x PEX Barb - Crimp Style
 NSF® Certified Lead Free

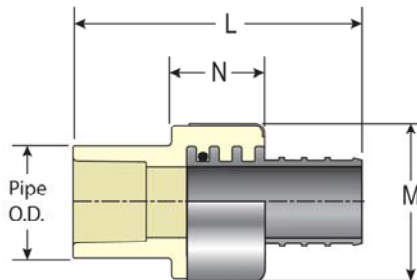

| Part Number | Size | L | M | N | Approx. Wt. (Lbs.) |
|-------------|-----------|---------|--------|-------|--------------------|
| TPC-005 | 1/2 | 1-31/32 | 1 | 23/32 | .06 |
| TPC-007 | 3/4 (1/2) | 2-1/4 | 1-7/32 | 13/16 | .12 |

CTS CPVC Technical
CTS Product Dimensions



CPVC-PEX Transition Spigot Adapters

Spigot x PEX Barb - Crimp Style
 NSF® Certified Lead Free

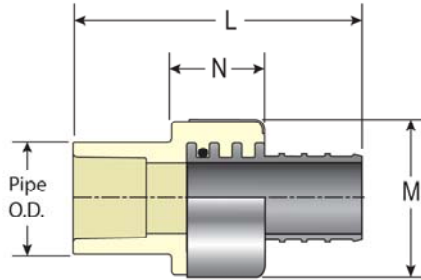

(Continued)

| Part Number | Size | L | M | N | Approx. Wt. (Lbs.) |
|-------------|---------|--------|--------|-----|--------------------|
| TPC-010 | 1 (3/4) | 2-9/32 | 1-7/16 | 1/2 | .11 |

ASTM F1807 Standard PEX Connector, Stainless Steel

CPVC-PEX Transition Socket Adapters

Socket x PEX Barb - Crimp Style
 NSF® Certified Lead Free

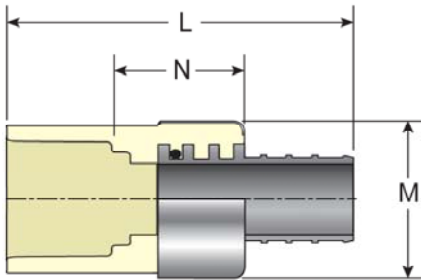

| Part Number | Size | L | M | N | Approx. Wt. (Lbs.) |
|-------------|-----------|--------|--------|-------|--------------------|
| TPC-005-S | 1/2 (3/4) | 2-1/8 | 1 | 29/32 | .07 |
| TPC-007-S | 3/4 (1) | 2-3/8 | 1-7/32 | 31/32 | .10 |
| TPC-010-S | 1 (1-1/4) | 2-9/32 | 1-7/16 | 19/32 | .11 |

ASTM F1807 Standard PEX Connector, Stainless Steel

Water Hammer Arrester

Spigot
 NSF® Certified Lead Free

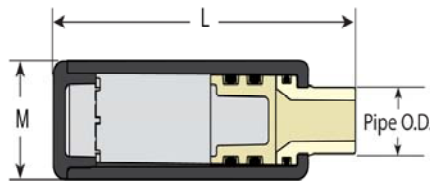

| Part Number | Size | L | M | Approx. Wt. (Lbs.) |
|-------------|------|-------|-------|--------------------|
| WHA-005 | 1/2 | 3-7/8 | 1-1/8 | .07 |



CTS CPVC Technical
CTS Product Dimensions

**Expansion Joint/Repair
 Couplings - Spigot x Socket**

CPVC With EPDM O-Rings
 NSF® Certified Lead Free

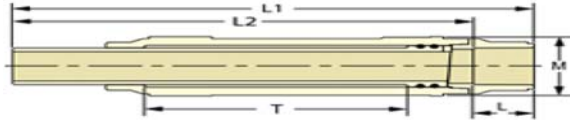

| Part Number | Size | L | L1 | L2 | M | T | Approx. Wt. (Lbs.) |
|-------------|------|-------|---------|---------|---------|---------|--------------------|
| CTS118-07 | 3/4 | 23/32 | 6-13/32 | 5-11/16 | 1-7/16 | 3-29/32 | .24 |
| CTS118-10 | 1 | 29/32 | 7-13/16 | 6-29/32 | 1-13/16 | 3-29/32 | .45 |

Unit Must Be Thrust Blocked. T = Repair Coupling Travel

**Expansion Joint/Repair
 Couplings - Socket x Socket**

CPVC With EPDM O-Rings
 NSF® Certified Lead Free

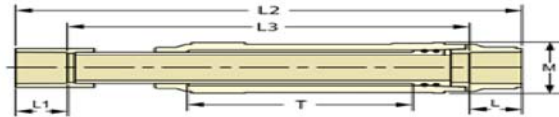

| Part Number | Size | L | L1 | L2 | L3 | M | T | Approx. Wt. (Lbs.) |
|-------------|------|-------|-------|---------|-------|---------|---------|--------------------|
| CTS119-07 | 3/4 | 23/32 | 23/32 | 7-3/16 | 5-3/4 | 1-7/16 | 2-17/32 | .27 |
| CTS119-10 | 1 | 29/32 | 29/32 | 8-27/32 | 7 | 1-13/16 | 3-29/32 | .50 |

Unit Must Be Thrust Blocked. T = Repair Coupling Travel

**Quarter Turn Angle Supply
 Stop**

Socket x NPT
 100 psi @ 180°F (82°C) Male Thread for
 Connection to Flexible Supply Line having 1/2"
 Female NPT Thread Inlet - NSF® Certified Lead
 Free

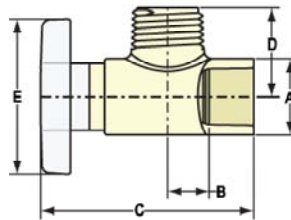

| Part Number | Size | A | B | C | D | E | Approx. Wt. (Lbs.) |
|-------------|------|-----|------|---------|---|--------|--------------------|
| 7722-005 | 1/2 | 7/8 | 7/16 | 2-13/16 | 1 | 2-1/16 | .07 |

CTS CPVC Technical
CTS Product Dimensions



Quarter Turn Angle Supply Stop

SR Fipt x NPT
 100 psi @ 180°F (82°C) Male Thread for Connection to Flexible Supply Line having 1/2" Female NPT Thread Inlet - NSF® Certified Lead Free

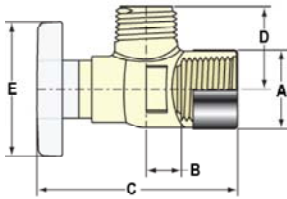

| Part Number | Size | A | B | C | D | E | Approx. Wt. (Lbs.) |
|-------------|------|--------|------|-------|--------|--------|--------------------|
| 7721-005SR | 1/2 | 1-1/32 | 7/16 | 2-5/8 | 1-1/16 | 2-1/16 | .11 |

Quarter Turn Angle Supply Stop

SR Fipt x Compression Thread
 100 psi @ 180°F (82°C) Male Thread for Connection to Flexible Supply Line having Female 3/8" Compression Thread Inlet - NSF® Certified Lead Free

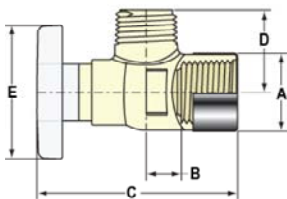

| Part Number | Size | A | B | C | D | E | Approx. Wt. (Lbs.) |
|-------------|---------|---------|------|--------|-------|--------|--------------------|
| 7721-073SR | 1/2X3/8 | 1- 1/32 | 7/16 | 2- 5/8 | 31/32 | 2-1/16 | .07 |

Quarter Turn Angle Supply Stop

Socket x Compression Thread
 100 psi @ 180°F (82°C) Male Thread for Connection to Flexible Supply Line having 1/4", 3/8" or 1/2" Female Compression Thread Inlet - NSF® Certified Lead Free

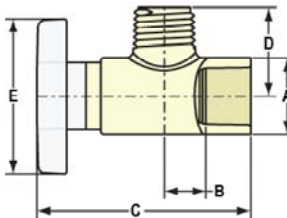

| Part Number | Size | A | B | C | D | E | Approx. Wt. (Lbs.) |
|-------------|---------|-------|------|---------|-----|--------|--------------------|
| 7722CM-072 | 1/2X1/4 | 27/32 | 7/16 | 2-3/8 | 7/8 | 2-1/16 | .07 |
| 7722-073 | 1/2X3/8 | 7/8 | 7/16 | 2-3/8 | 7/8 | 2-1/16 | .07 |
| 7722CM-005 | 1/2 | 7/8 | 7/16 | 2-13/32 | 1 | 2-1/16 | .07 |



CTS CPVC Technical
CTS Product Dimensions

Quarter Turn Straight Supply Stop

Socket x Compression Thread
100 psi @ 180°F (82°C) Male Thread for Connection to Flexible Supply Line having Female 3/8" or 1/2" Compression Thread Inlet - NSF® Certified Lead Free

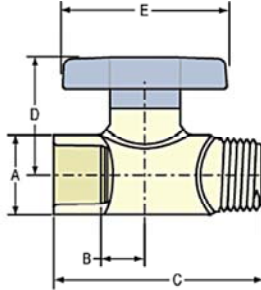

| Part Number | Size | A | B | C | D | E | Approx. Wt. (Lbs.) |
|-------------|---------|-------|-------|---------|---------|--------|--------------------|
| 7422CM-073 | 1/2X3/8 | 27/32 | 13/32 | 1-13/16 | 1-7/16 | 2-1/16 | .07 |
| 7422CM-005 | 1/2 | 27/32 | 13/32 | 2-1/32 | 1-13/32 | 2-1/16 | .07 |

Quarter Turn Straight Supply Stop

Socket x NPT
100 psi @ 180°F (82°C) Male Thread for Connection to Flexible Supply Line having Female 1/2" NPT Thread Inlet - NSF® Certified Lead Free

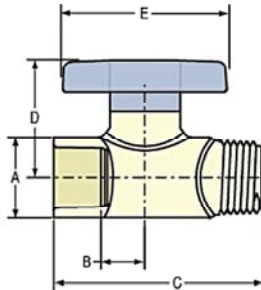

| Part Number | Size | A | B | C | D | E | Approx. Wt. (Lbs.) |
|-------------|------|-------|-------|--------|---------|--------|--------------------|
| 7422-005 | 1/2 | 27/32 | 13/32 | 2-1/32 | 1-13/32 | 2-1/16 | .07 |



Ball Valve - Commercial CTS

Socket with EPDM O-ring Seal
100 psi Maximum Internal Pressure @ 180°F (82°C) NSF® Certified Lead Free

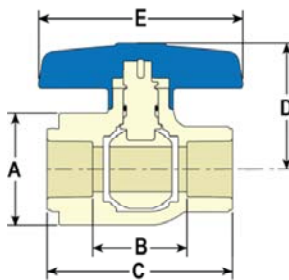

| Part Number | Size | A | B | C | D | E | Cv Values | Approx. Wt. (Lbs.) |
|-------------|------|---------|--------|---------|---------|---------|-----------|--------------------|
| 1922-005 | 1/2 | 1-7/16 | 1-3/16 | 2-5/8 | 1-11/16 | 2-23/32 | 37 | .17 |
| 1922-007 | 3/4 | 1-25/32 | 1-7/16 | 2-29/32 | 2-1/32 | 3-7/32 | 84 | .25 |

CTS CPVC Technical
CTS Product Dimensions



Ball Valve - Commercial CTS

Socket with EPDM O-ring Seal
 100 psi Maximum Internal Pressure @ 180°F
 (82°C) NSF® Certified Lead Free

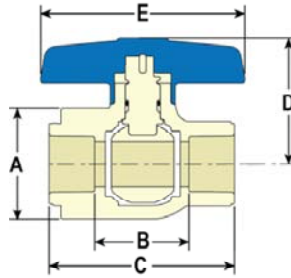

(Continued)

| Part Number | Size | A | B | C | D | E | Cv Values | Approx. Wt. (Lbs.) |
|-------------|-------|---------|---------|---------|---------|---------|-----------|--------------------|
| 1922-010 | 1 | 2-1/16 | 1-19/32 | 3-7/16 | 2-3/8 | 3-1/2 | 151 | .37 |
| 1922-012 | 1-1/4 | 2-9/16 | 1-7/8 | 3-13/16 | 2-13/16 | 3-3/4 | 229 | .68 |
| 1922-015 | 1-1/2 | 2-15/16 | 2-7/16 | 4-5/8 | 3-1/8 | 4-1/4 | 330 | .98 |
| 1922-020 | 2 | 3-19/32 | 2-25/32 | 5-1/8 | 3-27/32 | 4-31/32 | 598 | 1.46 |

Ball Valve - Residential CTS

Socket x Socket
 100 psi Maximum Internal Pressure @ 180°F
 (82°C) NSF® Certified Lead Free

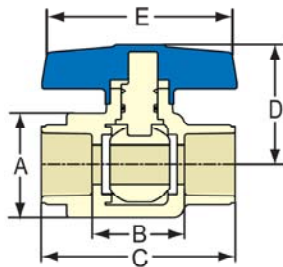

| Part Number | Size | A | B | C | D | E | Approx. Wt. (Lbs.) |
|-------------|-------|---------|---------|---------|---------|---------|--------------------|
| 1922R-005 | 1/2 | 1-1/8 | 1 | 2-1/16 | 1-9/32 | 2 | .09 |
| 1922R-007 | 3/4 | 1-1/2 | 1-11/32 | 2-25/32 | 1-23/32 | 2-23/32 | .17 |
| 1922R-010 | 1 | 1-13/16 | 1-9/16 | 3-13/32 | 2-5/16 | 3-1/2 | .28 |
| 1922R-012 | 1-1/4 | 1-29/32 | 1-9/16 | 3-13/16 | 2-3/8 | 3-1/2 | .33 |
| 1922R-015 | 1-1/2 | 2-7/16 | 1-7/8 | 4-1/2 | 2-13/16 | 3-3/4 | .55 |
| 1922R-020 | 2 | 2-7/8 | 2-11/32 | 5-25/32 | 3-1/8 | 4-1/4 | .92 |

Stop Valve - Red Handle

Socket x Socket
 NSF® Certified Lead Free

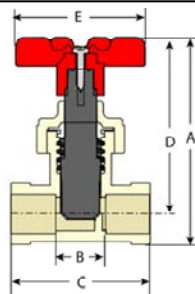

| Part Number | Size | A | B | C | D | E | Approx. Wt. (Lbs.) |
|-------------|------|-------|---|--------|---------|-------|--------------------|
| 8422-005 | 1/2 | 3-1/4 | 1 | 2-5/32 | 2-13/16 | 2-1/8 | .12 |
| 8422-007 | 3/4 | 3-3/8 | 1 | 2-1/2 | 2-3/4 | 2-1/8 | .15 |



CTS CPVC Technical
CTS Product Dimensions

Stop Valve - Clear Handle

Socket x Socket
NSF® Certified Lead Free

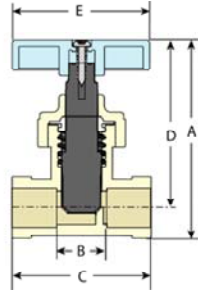

| Part Number | Size | A | B | C | D | E | Approx. Wt. (Lbs.) |
|-------------|------|---------|---|--------|--------|--------|--------------------|
| 8422CH-005 | 1/2 | 2-31/32 | 1 | 2-5/32 | 2-1/2 | 2-1/16 | .12 |
| 8422CH-007 | 3/4 | 3-1/16 | 1 | 2-1/2 | 2-7/16 | 2-1/16 | .15 |

Stop & Waste Valve

Socket x Socket
NSF® Certified Lead Free

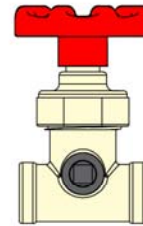
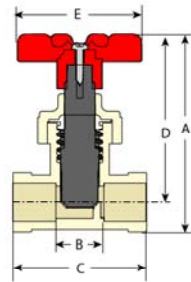

| Part Number | Size | A | B | C | D | E | Approx. Wt. (Lbs.) |
|-------------|------|--------|-------|--------|---------|-------|--------------------|
| 8422W-005 | 1/2 | 3-7/32 | 13/16 | 1-7/8 | 2-3/4 | 2-1/8 | .19 |
| 8422W-007 | 3/4 | 3-1/4 | 1 | 2-7/16 | 2-23/32 | 2-1/8 | .20 |

Boiler Drain Valve

Socket x MHT
NSF® Certified Lead Free

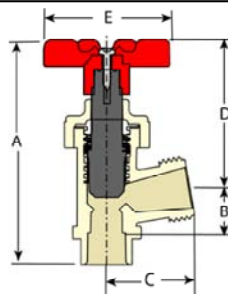

| Part Number | Size | A | B | C | D | E | Approx. Wt. (Lbs.) |
|-------------|------|---------|-----|--------|--------|-------|--------------------|
| 82MH-005 | 1/2 | 3-23/32 | 3/4 | 1-7/16 | 2-7/16 | 2-1/8 | .13 |
| 82MH-007 | 3/4 | 3-7/8 | 3/4 | 1-7/16 | 2-7/16 | 2-1/8 | .16 |



CTS CPVC Technical
CTS Product Dimensions



Pipe - CPVC CTS SDR 11

10' Lengths
 NSF® Certified Lead Free

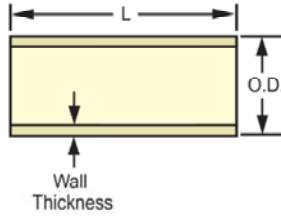

| Part Number | Size | L | AVG.O.D. | Minimum Wall | Approx. Wt. (Lbs./Ft) |
|-------------|-------|----|----------|--------------|-----------------------|
| CTS-005 | 1/2 | 10 | .625 | .060 | .07 |
| CTS-007 | 3/4 | 10 | .875 | .080 | .14 |
| CTS-010 | 1 | 10 | 1.125 | .102 | .24 |
| CTS-012 | 1-1/4 | 10 | 1.375 | .125 | .34 |
| CTS-015 | 1-1/2 | 10 | 1.625 | .148 | .50 |
| CTS-020 | 2 | 10 | 2.125 | .193 | .71 |

Pipe - CPVC CTS SDR 11

20' Lengths
 NSF® Certified Lead Free

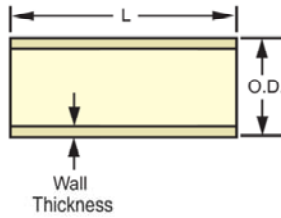

| Part Number | Size | L | AVG.O.D. | Minimum Wall | Approx. Wt. (Lbs./Ft) |
|-------------|-------|----|----------|--------------|-----------------------|
| CTS-005-20 | 1/2 | 20 | .625 | .060 | .07 |
| CTS-007-20 | 3/4 | 20 | .875 | .080 | .14 |
| CTS-010-20 | 1 | 20 | 1.125 | .102 | .24 |
| CTS-012-20 | 1-1/4 | 20 | 1.375 | .125 | .34 |
| CTS-015-20 | 1-1/2 | 20 | 1.625 | .148 | .50 |
| CTS-020-20 | 2 | 20 | 2.125 | .193 | .71 |

