

- Discount Code(s): 035 CPVC CTS Fittings \_\_\_\_\_  
 046 PVC Schedule 40 Molded Reinforced Fittings \_\_\_\_\_  
 076 CPVC Fire Spinkler Fittings w/Metal Inserts \_\_\_\_\_  
 085 CPVC & PVC Expansion Joints \_\_\_\_\_  
 086 PVC Schedule 80 Molded Reinforced Fittings \_\_\_\_\_  
 096 CPVC Schedule 80 Molded Reinforced Fittings \_\_\_\_\_  
 100 PVC Tank Adapters (Bulkhead Fittings) \_\_\_\_\_  
 101 CPVC Tank Adapters (Bulkhead Fittings) \_\_\_\_\_  
 895 Blue 75 Thread Sealant \_\_\_\_\_



*Item prices may have changed from those shown in this sheet. See Spears® On-line Catalog for most current pricing, updated daily.*

# Special Reinforced (SR) & Metal Thread Transition Fittings & Adapters



Quality Systems Certificate No. 293  
 Corporate Facilities, Sylmar, CA  
 Assessed to ISO 9001: 2008

Visit our web site:  
[www.spearsmfg.com](http://www.spearsmfg.com)

PRICE SCHEDULE TRAN-1-0910  
 Effective September 26, 2010  
 Supersedes TRAN-1-1009



## Special Reinforced (SR) & Metal Thread Transition Fittings & Adapters

### TRANSITION FITTINGS OVERVIEW

Spears® Transition fittings are designed primarily for adapting plastic-to-metal systems. These fittings, especially the Special Reinforced (SR) Female Plastic Thread style, can also be used for superior strength in make-up of plastic threaded joints. Spears® offers a variety of transition adapter fittings specified below. All have standard ASTM socket sizes for IPS pipe and NPT threads, except for the Gasket Sealed style that uses a straight thread with elastomer seal. All other threads should be assembled with a quality grade thread sealant that is compatible with plastics.

**Warning:** Some pipe joint compounds or Teflon® pastes may contain substances that could cause stress cracking in thermoplastic materials. Spears® recommends the use of Spears® **BLUE 75™** thread sealant that has been tested for compatibility with Spears® products. Choice of any other appropriate thread sealant is at the discretion of the installer.

**Special Reinforced (SR) Thread Fittings:** This patented fitting features all-plastic female thread construction that reduces problems associated with over-tightening of female plastic pipe threads. The external reinforcing collar is not just an added reinforcement ring, this unique precompression design compensates for expansion forces generated from tapered pipe thread joint make-up. Radial stress is reduced in normal installations and contained in severe over-tightening situations. The all-plastic internal construction provides for the maximum in chemical and corrosion benefits. Its solid construction and reliability make the SR our best transition design for all applications.

**Brass Thread Fitting:** This patented fitting features a molded-in-place brass thread with external reinforcing collar as an integral part of each fitting for superior strength. An internal form-compressed O-ring seal compensates for expansion and contraction variations between materials. Excellent as a metal-to-plastic transition adapter fitting.

**Male Brass Thread Fitting:** Developed for Copper Tube Size (CTS) hot-and-cold water distribution systems, this male brass thread alternative is the only metal thread design of its type that has the metal component lined with plastic for improved fitting construction and minimal exposure. Excellent for transition to female metal threads in a CTS system.

**Gasket Sealed Thread Fittings:** Also developed for Copper Tube Size (CTS) hot-and-cold water distribution systems, this female threaded fitting features all plastic internal construction for maximum corrosion resistance. The fitting incorporates straight-threads for mechanical connection, while sealing is accomplished through an internal elastomer gasket or O-ring against the pipe face. No sealants are used.

### APPROVALS

Spears® Transition Fittings/Materials are approved for use in potable water systems by NSF International under ANSI/NSF Standard 61, Drinking Water System Components - Health Effects.

CPVC Orange Fittings in this price schedule (4200 series part numbers) are approved by Underwriters Laboratories, FM Global, and LPCB for use in CPVC Fire Sprinkler Systems. When installed in these system, installation must be made in accordance with Spears® publication FG-3, *FlameGuard® CPVC Fire Sprinkler Products Installation Manual*, and local codes. However, these fittings can also be used in many other types of installations. CPVC fittings may also be used on PVC pipe when installed using a quality CPVC solvent cement meeting the requirements of ASTM F 493, Standard Specification for Solvent Cements for Chlorinated Poly (Vinyl Chloride) (CPVC) Plastic Pipe and Fittings.

NOT FOR USE WITH COMPRESSED AIR OR GAS

# Special Reinforced (SR) & Metal Thread Transition Fittings & Adapters



## HOW TO USE THIS CATALOG

Spears® *Transition Fittings & Adapters* provides a concise listing of products specially designed for making plastic-to-metal system transitions. These include Spears® patented designs for Special Reinforced (SR) Female Plastic Thread Fittings and plastic fittings with molded-in Brass Threads. Selection can be made according to fitting material and type/color and then by part number with size, packaging and pricing information. Additional fitting types and configurations can be found in Spears® standard catalogs for each fitting material.

## ORGANIZATION

Products in this catalog are listed first by material type and color, then according to fitting transition-type and fitting configuration. Similar configurations such as Tees, Elbows, Adapters, etc., are grouped together according to size.

## PAGE & COLUMN HEADER INFORMATION

Each page header identifies the material, color and fitting transition-type. For example:

### PVC White Special Reinforced (SR) Fittings

Each product column header label identifies the following product particulars:

Part Number	the number used to order the part.
Size	nominal diameter of pipe with which the fitting is to be used. NOTE: Fittings may be same size (only one size designation) or reducing (multiple sizes designated).
Standard Pack (Std Pk)	the quantity of parts packaged in an individual box or bag.
Master Carton (Mstr Ctn)	the total quantity of parts contained in individual boxes or bags which are packaged together.
Discount Code (Disc Code)	identification code for applicable discount to the list price of the product. NOTE: This is a Product Group code and is not a calculation of discount. Discount codes are not the same for all products contained in this price schedule.
Price Each	the designated list price of the product.

## PRODUCT CONFIGURATION

Each group of product configuration types is headed by the product's name. An abbreviated configuration description of the fitting outlet connection is listed below the column headers. Line drawing illustrations are general representations of the fittings in the group, but may not be an exact depiction of all configurations listed. Line drawings are correlated to the configuration description. The drawing is read left to right for Elbow and Adapter configurations; bushings are read as outside x inside configuration. Tees have an additional outlet branch and are read left to right (run) then top (branch). The configuration description also correlates to the size designation. As with the nominal size designations, only one description is given when all outlets are the same. Reducing sizes list run configuration x branch configuration. Refer to illustration below:

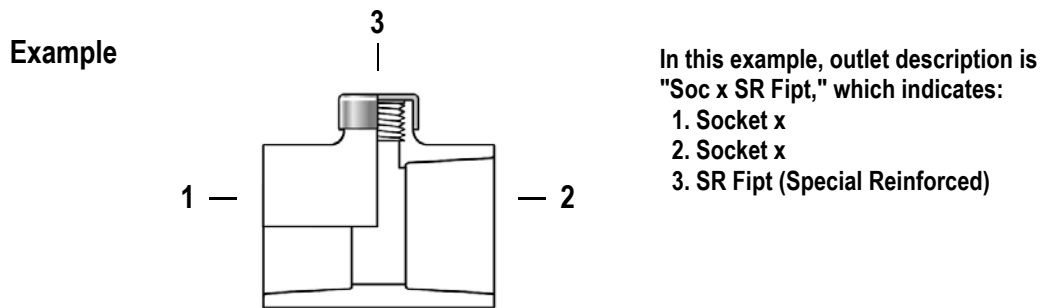

<b>Product Name</b>	<b>Special Reinforced Reducing Tee</b>																								
<b>Abbreviated Configuration Description</b>	<b>Soc x SR Fipt - Stainless Steel Collar</b>																								
	<table border="1" style="width: 100%; border-collapse: collapse; text-align: center;"> <thead> <tr> <th style="text-align: left;">Part Number</th> <th style="text-align: left;">Size</th> <th>Std Pk</th> <th>Mstr Ctn</th> <th>Disc Code</th> <th>Price Each</th> </tr> </thead> <tbody> <tr> <td>402-072SR</td> <td>1/2X1/4</td> <td>25</td> <td>150</td> <td>046</td> <td>7.66</td> </tr> <tr> <td>402-098SR</td> <td>3/4X1/4</td> <td>25</td> <td>100</td> <td>046</td> <td>9.95</td> </tr> <tr> <td>402-101SR</td> <td>3/4X1/2</td> <td>50</td> <td>0</td> <td>046</td> <td>9.95</td> </tr> </tbody> </table>	Part Number	Size	Std Pk	Mstr Ctn	Disc Code	Price Each	402-072SR	1/2X1/4	25	150	046	7.66	402-098SR	3/4X1/4	25	100	046	9.95	402-101SR	3/4X1/2	50	0	046	9.95
Part Number	Size	Std Pk	Mstr Ctn	Disc Code	Price Each																				
402-072SR	1/2X1/4	25	150	046	7.66																				
402-098SR	3/4X1/4	25	100	046	9.95																				
402-101SR	3/4X1/2	50	0	046	9.95																				



# PVC White Special Reinforced (SR) Fittings

Part Number	Size	Std Pk	Mstr Ctn	Disc Code	Price Each
-------------	------	--------	----------	-----------	------------

### Special Reinforced Female Adapter Soc x SR Fipt - Stainless Steel Collar

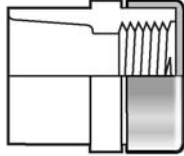

435-002SR	1/4	25	450	046	5.31
435-003SR	3/8	25	300	046	5.31
435-005SR	1/2	25	300	046	2.95
435-007SR	3/4	25	300	046	4.29
435-010SR	1	25	200	046	6.38
435-012SR	1-1/4	10	60	046	10.32
435-015SR	1-1/2	10	80	046	12.70
435-020SR	2	10	0	046	22.15
435-025SR	2-1/2	5	0	046	34.95
435-030SR	3	10	0	046	39.38
435-040SR	4	5	0	046	67.68

### Special Reinforced Tee Soc x SR Fipt - Stainless Steel Collar

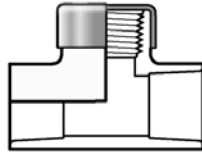

402-005SR	1/2	25	200	046	7.66
402-012SR	1-1/4	25	0	046	15.06

### Special Reinforced Reducing Tee Soc x SR Fipt - Stainless Steel Collar

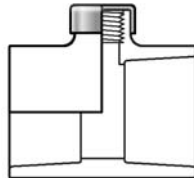

402-072SR	1/2X1/4	25	150	046	7.66
402-098SR	3/4X1/4	25	100	046	9.95
402-101SR	3/4X1/2	50	0	046	9.95
402-166SR	1-1/4X1/2	15	0	046	16.64
402-168SR	1-1/4X1	10	0	046	16.98
402-212SR	1-1/2X1-1/4	10	0	046	18.38
402-287SR	2-1/2X1/2	10	0	046	22.37
402-288SR	2-1/2X3/4	10	0	046	23.64
402-289SR	2-1/2X1	10	0	046	23.87
402-290SR	2-1/2X1-1/4	10	0	046	23.50
402-291SR	2-1/2X1-1/2	10	0	046	24.43
402-292SR	2-1/2X2	10	0	046	24.63
402-333SR	3X1/2	10	0	046	29.83
402-334SR	3X3/4	10	0	046	29.83
402-335SR	3X1	10	0	046	30.43
402-336SR	3X1-1/4	10	0	046	31.14
402-337SR	3X1-1/2	10	0	046	30.87

Part Number	Size	Std Pk	Mstr Ctn	Disc Code	Price Each
-------------	------	--------	----------	-----------	------------

### Special Reinforced Reducing Tee Soc x SR Fipt - Stainless Steel Collar (continued)

402-338SR	3X2	6	0	046	32.70
402-417SR	4X1	6	0	046	39.51
402-419SR	4X1-1/2	10	0	046	43.40
402-420SR	4X2	10	0	046	44.81
402-422SR	4X3	6	0	046	70.40

### Special Reinforced Reducing Tee Soc x SR Fipt-Stainless Steel Collar x Soc

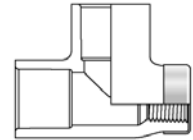

403-095SR	3/4X1/2X3/4	50	0	046	2.59
-----------	-------------	----	---	-----	------

### Special Reinforced 90° Ell & Reducing 90° Ell Soc x SR Fipt - Stainless Steel Collar

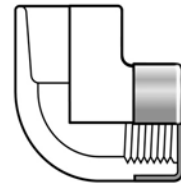

407-005SR	1/2	50	400	046	6.79
407-007SR	3/4	75	0	046	8.72
407-010SR	1	50	0	046	8.82
407-131SR	1X3/4	50	0	046	3.74
407-168SR <sup>1</sup>	1-1/4X1	25	0	046	14.77
407-249SR	2X1	10	0	046	16.80
407-251SR	2X1-1/2	10	0	046	17.72

Sized with SR Adapter

### Special Reinforced Coupling SR Fipt - Stainless Steel Collar

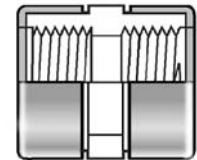

430-005SR	1/2	25	300	046	3.51
430-007SR	3/4	25	300	046	4.99
430-010SR	1	25	200	046	5.33
430-012SR	1-1/4	10	120	046	6.64
430-015SR	1-1/2	10	60	046	14.70
430-020SR	2	10	0	046	15.41

NOT FOR USE WITH COMPRESSED AIR OR GAS

# PVC White Special Reinforced (SR) Fittings



Part Number	Size	Std Pk	Mstr Ctn	Disc Code	Price Each
-------------	------	--------	----------	-----------	------------

**Special Reinforced Reducer Coupling**  
SR Fipt - Stainless Steel Collar

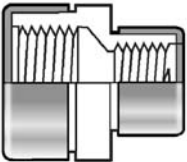

430-101SR	3/4X1/2	50	200	046	7.56
-----------	---------	----	-----	-----	------

**Special Reinforced Spigot Female Adapter**  
Spig x SR Fipt - Stainless Steel Collar

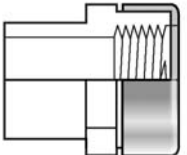

478-005SR	1/2	50	600	046	3.88
478-007SR	3/4	25	300	046	4.57
478-010SR	1	50	0	046	7.04
478-012SR	1-1/4	25	0	046	11.21
478-015SR	1-1/2	25	0	046	13.44
478-020SR	2	15	0	046	22.37
478-030SR	3	5	0	046	41.12
478-040SR	4	5	0	046	63.51

**Special Reinforced Reducing Spigot Female Adapter**  
Spig x SR Fipt - Stainless Steel Collar

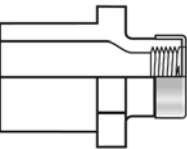

478-072SR	1/2X1/4	25	450	046	10.78
478-098SR	3/4X1/4	50	300	046	15.70
478-128SR	1X1/4	50	400	046	16.19

Spears® SR Series reinforced spigot adapters can be user-installed in a variety of socket type tees, elbows and reducer bushings for superior thread reinforcement demanding applications.

**Special Reinforced Reducing Female Adapter**  
Soc x SR Fipt - Stainless Steel Collar

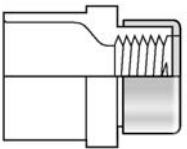

435-072SR	1/2x1/4	50	600	046	3.86
435-074SR	1/2X3/4	50	400	046	4.29
435-101SR	3/4X1/2	50	400	046	4.29
435-102SR	3/4X1	50	0	046	6.38
435-130SR	1X1/2	50	0	046	6.38
435-131SR	1X3/4	25	200	046	6.38

Part Number	Size	Std Pk	Mstr Ctn	Disc Code	Price Each
-------------	------	--------	----------	-----------	------------

**Special Reinforced Reducer Bushing Flush Style**  
Spig x SR Fipt - Stainless Steel Collar

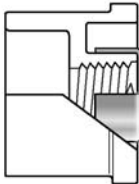

438-128SR	1X-1/4	25	300	046	3.14
438-166SR	1-1/4X1/2	25	100	046	5.74
438-207SR	1-1/2X1/4	25	100	046	8.01
438-209SR	1-1/2X1/2	25	100	046	8.01
438-210SR	1-1/2X3/4	25	100	046	8.01
438-247SR	2X1/2	10	80	046	9.80
438-248SR	2X3/4	10	80	046	9.80
438-249SR	2X1	10	80	046	9.80
438-334SR	3X3/4	10	0	046	38.36
438-335SR	3X1	10	0	046	38.36
438-336SR	3X-1/4	10	0	046	38.36
438-337SR	3X1-1/2	10	0	046	38.36
438-420SR	4X2	6	0	046	58.97
438-421SR	4X2-1/2	6	0	046	66.37
438-528SR	6X2	5	0	046	67.91
438-530SR	6X3	5	0	046	61.13
438-532SR	6X4	5	0	046	67.91

**Special Reinforced Reducer Bushing Flush Style**  
Mipt x SR Fipt - Stainless Steel Collar

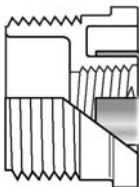

439-209SR	1-1/2X1/2	25	200	046	8.30
439-249SR	2X1	10	120	046	12.19

**Special Reinforced Cap**  
SR Fipt - Stainless Steel Collar

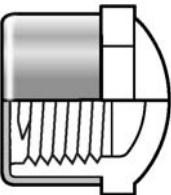

448-012SR	1-1/4	25	100	046	6.40
-----------	-------	----	-----	-----	------

NOT FOR USE WITH COMPRESSED AIR OR GAS

Made in the U.S.A.

**Progressive Products from Spears® Innovation and Technology**



# PVC White Special Reinforced (SR) Fittings

Part Number	Size	Std Pk	Mstr Ctn	Disc Code	Price Each
-------------	------	--------	----------	-----------	------------

**Special Reinforced Union**  
**Soc x SR Fipt with Buna O-ring Seal -**  
**Stainless Steel Collar**

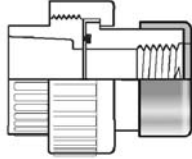

459-002SR	1/4	25	150	046	14.55
459-003SR	3/8	25	100	046	14.55
459-005SR	1/2	10	60	046	7.90
459-007SR	3/4	10	40	046	10.88
459-010SR	1	10	0	046	14.48
459-012SR	1-1/4	5	20	046	27.64
459-015SR	1-1/2	5	0	046	34.21
459-020SR	2	5	0	046	52.69
459-030SR	3	5	0	046	124.40
459-040SR	4	4	0	046	142.83
459-060SR	6	1	0	046	317.40

**Special Reinforced Union**  
**Soc x SR Fipt with EPDM O-ring Seal -**  
**Stainless Steel Collar**

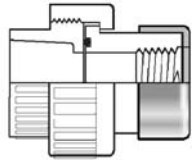

499-002SR	1/4	25	150	046	15.98
499-003SR	3/8	25	100	046	15.98
499-005SR	1/2	10	60	046	8.68
499-007SR	3/4	10	40	046	11.96
499-010SR	1	10	40	046	15.89
499-012SR	1-1/4	5	20	046	30.37
499-015SR	1-1/2	5	0	046	37.60
499-020SR	2	5	0	046	57.90
499-030SR	3	5	0	046	136.71
499-040SR	4	4	0	046	156.95
499-060SR	6	1	0	046	348.80

NOT FOR USE WITH COMPRESSED AIR OR GAS

# PVC White Brass Thread Fittings



Part Number	Size	Std Pk	Mstr Ctn	Disc Code	Price Each
-------------	------	--------	----------	-----------	------------

**Transition Union  
Soc x Fipt with Brass Thread Insert & Buna-N O-ring Seal**

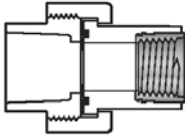

459-010BR	1	10	0	046	61.50
459-012BR	1-1/4	5	20	046	103.32
459-015BR	1-1/2	5	0	046	136.70
459-020BR	2	5	0	046	182.34

Not intended to convey or dispense water for human consumption through drinking or cooking

**Transition Union  
Soc x Fipt with Brass Thread Insert & EPDM O-ring Seal**

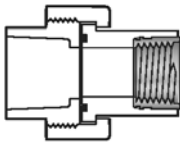

499-010BR	1	10	0	046	61.50
499-012BR	1-1/4	5	20	046	103.32
499-015BR	1-1/2	5	0	046	136.70
499-020BR	2	5	0	046	182.34

Not intended to convey or dispense water for human consumption through drinking or cooking

NOT FOR USE WITH COMPRESSED AIR OR GAS

Made in the U.S.A.

**Progressive Products from Spears® Innovation and Technology**



# PVC Gray Special Reinforced (SR) Fittings

Part Number	Size	Std Pk	Mstr Ctn	Disc Code	Price Each
-------------	------	--------	----------	-----------	------------

### Special Reinforced Tee Soc x SR Fipt - Stainless Steel Collar

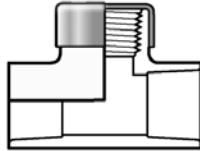

802-005SR	1/2	25	200	086	7.66
802-007SR	3/4	15	120	086	10.83
802-010SR	1	15	0	086	12.72
802-012SR	1-1/4	25	0	086	15.13
802-015SR	1-1/2	10	0	086	15.99
802-030SR	3	5	0	086	67.60
802-040SR	4	5	0	086	126.78

### Special Reinforced Tee SR Fipt - Stainless Steel Collar

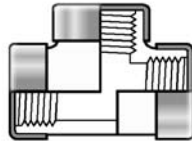

805-002SR	1/4	25	150	086	8.91
805-003SR	3/8	25	150	086	8.91
805-005SR	1/2	25	150	086	9.20
805-007SR	3/4	25	100	086	10.11
805-010SR	1	15	0	086	24.03
805-015SR	1-1/2	10	0	086	28.12
805-020SR	2	10	0	086	29.56

### Special Reinforced Reducing Tee Soc x SR Fipt - Stainless Steel Collar

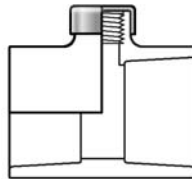

802-072SR	1/2X1/4	25	150	086	7.66
802-098SR	3/4X1/4	25	100	086	9.95
802-101SR	3/4X1/2	50	0	086	9.95
802-128SR <sup>1</sup>	1X1/4	10	80	086	23.55
802-130SR	1X1/2	50	0	086	12.27
802-131SR	1X3/4	15	0	086	23.55
802-164SR <sup>1</sup>	1-1/4X1/4	5	0	086	25.11
802-166SR	1-1/4X1/2	25	0	086	16.64
802-168SR	1-1/4X1	10	0	086	16.98
802-207SR <sup>1</sup>	1-1/2X1/4	10	0	086	29.30
802-211SR	1-1/2X1	10	0	086	18.38
802-212SR	1-1/2X1-1/4	10	0	086	18.38
802-245SR <sup>1</sup>	2X1/4	10	0	086	33.84
802-247SR	2X1/2	10	0	086	33.84
802-248SR	2X3/4	10	0	086	33.84
802-287SR	2-1/2X1/2	10	0	086	24.94

Part Number	Size	Std Pk	Mstr Ctn	Disc Code	Price Each
-------------	------	--------	----------	-----------	------------

### Special Reinforced Reducing Tee Soc x SR Fipt - Stainless Steel Collar (continued)

802-331SR <sup>1</sup>	3X1/4	5	0	086	64.60
802-333SR <sup>1</sup>	3X1/2	5	0	086	66.47
802-413SR <sup>1</sup>	4X1/4	5	0	086	88.96
802-415SR <sup>1</sup>	4X1/2	5	0	086	96.68

<sup>1</sup> Sized with Bushing

### Special Reinforced Reducing Tee Soc x SR Fipt - Stainless Steel Collar x Soc

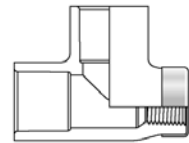

803-095SR	3/4X1/2X3/4	15	0	086	12.53
-----------	-------------	----	---	-----	-------

### Special Reinforced 90° Ell Soc x SR Fipt - Stainless Steel Collar

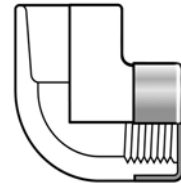

807-005SR	1/2	20	240	086	7.33
807-007SR	3/4	75	0	086	8.72
807-010SR	1	50	0	086	8.82
807-012SR	1-1/4	25	0	086	11.85
807-015SR	1-1/2	10	0	086	14.64
807-020SR	2	10	0	086	16.80
807-030SR	3	5	0	086	42.65
807-040SR	4	5	0	086	75.35

### Special Reinforced 90° Ell SR Fipt - Stainless Steel Collar

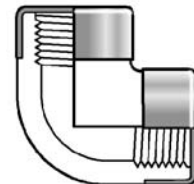

808-003SR	3/8	25	150	086	4.28
808-005SR	1/2	20	120	086	4.28
808-007SR	3/4	20	120	086	5.39
808-010SR	1	50	0	086	6.27
808-012SR	1-1/4	25	0	086	6.70
808-015SR	1-1/2	10	0	086	10.45

NOT FOR USE WITH COMPRESSED AIR OR GAS

Spears® Manufacturing Company



# PVC Gray Special Reinforced (SR) Fittings



Part Number	Size	Std Pk	Mstr Ctn	Disc Code	Price Each
-------------	------	--------	----------	-----------	------------

## Special Reinforced 90° Ell SR Fipt - Stainless Steel Collar (continued)

808-020SR	2	10	0	086	11.77
-----------	---	----	---	-----	-------

## Special Reinforced Reducing 90° Ell Soc x SR Fipt - Stainless Steel Collar

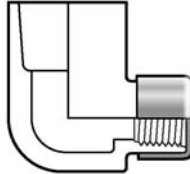

807-101SR	3/4X1/2	50	0	086	8.70
807-130SR	1X1/2	50	0	086	9.77

## Special Reinforced 45° Ell SR Fipt - Stainless Steel Collar

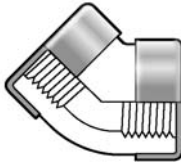

819-007SR	3/4	10	120	086	7.37
-----------	-----	----	-----	-----	------

## Special Reinforced Coupling SR Fipt - Stainless Steel Collar

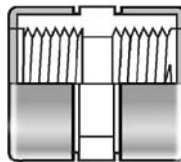

830-005SR	1/2	25	150	086	3.51
830-007SR	3/4	25	150	086	4.99
830-010SR	1	25	200	086	5.33
830-012SR	1-1/4	10	120	086	6.64
830-015SR	1-1/2	10	80	086	14.70
830-020SR	2	10	0	086	15.41

## Special Reinforced Reducer Coupling SR Fipt - Stainless Steel Collar

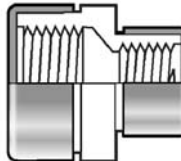

830-101SR	3/4X1/2	50	200	086	4.54
830-130SR	1X1/2	50	0	086	6.74
830-131SR	1X3/4	25	200	086	6.74
830-168SR	1-1/4X1	25	0	086	14.46

Part Number	Size	Std Pk	Mstr Ctn	Disc Code	Price Each
-------------	------	--------	----------	-----------	------------

## Special Reinforced Reducer Coupling SR Fipt - Stainless Steel Collar (continued)

830-210SR	1-1/2X3/4	25	0	086	21.46
830-211SR	1-1/2X1	10	80	086	21.46
830-212SR	1-1/2X1-1/4	10	80	086	21.46
830-249SR	2X1	25	0	086	28.44
830-251SR	2X1-1/2	10	0	086	28.44

## Special Reinforced Female Adapter Soc x SR Fipt - Stainless Steel Collar

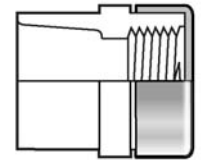

835-002SR	1/4	25	450	086	5.31
835-003SR	3/8	25	300	086	5.31
835-005SR	1/2	25	300	086	2.95
835-007SR	3/4	25	300	086	4.29
835-010SR	1	25	200	086	6.38
835-012SR	1-1/4	10	60	086	10.32
835-015SR	1-1/2	10	80	086	12.70
835-020SR	2	10	0	086	22.15
835-025SR	2-1/2	5	0	086	34.95
835-030SR	3	15	0	086	39.38
835-040SR	4	5	0	086	67.68
835-060SR	6	6	0	086	87.93

## Encapsulated Special Reinforced Female Adapter Soc x ESR Fipt

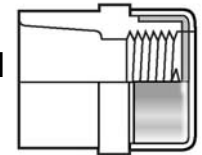

835-002ESR	1/4	25	450	086	7.69
835-003ESR	3/8	25	300	086	7.69
835-005ESR	1/2	25	300	086	4.77
835-007ESR	3/4	25	300	086	7.04
835-010ESR	1	25	200	086	9.32
835-012ESR	1-1/4	10	80	086	15.04
835-015ESR	1-1/2	10	80	086	21.73
835-020ESR	2	10	0	086	32.30

NOT FOR USE WITH COMPRESSED AIR OR GAS

Made in the U.S.A.

Progressive Products from Spears® Innovation and Technology

Page 8



# PVC Gray Special Reinforced (SR) Fittings

Part Number	Size	Std Pk	Mstr Ctn	Disc Code	Price Each
-------------	------	--------	----------	-----------	------------

**Special Reinforced Spigot Female Adapter**  
Spig x SR Fipt - Stainless Steel Collar

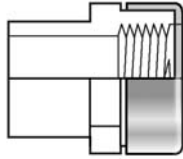

878-005SR	1/2	50	600	086	3.88
878-007SR	3/4	25	300	086	4.57
878-010SR	1	50	0	086	7.04
878-012SR	1-1/4	25	0	086	11.21
878-015SR	1-1/2	25	0	086	13.44
878-020SR	2	15	0	086	22.37
878-030SR	3	5	0	086	41.12
878-040SR	4	5	0	086	69.81

**Encapsulated Special Reinforced Spigot Female Adapter**  
Spig x ESR Fipt

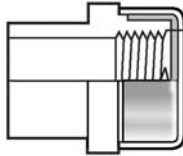

878-005ESR	1/2	50	600	086	5.29
878-007ESR	3/4	25	300	086	7.29
878-010ESR	1	50	0	086	10.00
878-012ESR	1-1/4	25	0	086	15.39
878-015ESR	1-1/2	25	0	086	21.85
878-020ESR	2	15	0	086	32.93

**Special Reinforced Reducing Female Adapter**  
Soc x SR Fipt - Stainless Steel Collar

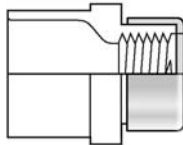

835-074SR	1/2X3/4	50	400	086	4.29
835-101SR	3/4X1/2	50	400	086	4.29
835-102SR	3/4X1	50	0	086	6.38
835-130SR	1X1/2	50	0	086	6.38
835-131SR	1X3/4	25	200	086	6.38

Part Number	Size	Std Pk	Mstr Ctn	Disc Code	Price Each
-------------	------	--------	----------	-----------	------------

**Special Reinforced Reducing Spigot Female Adapter**  
Spig x SR Fipt - Stainless Steel Collar

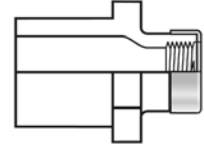

878-072SR	1/2X1/4	25	450	086	10.78
878-098SR	3/4X1/4	50	400	086	14.86
878-128SR	1X1/4	50	400	086	15.32

**Reinforced Male Adapter**  
R Mipt x Soc - Stainless Steel Sleeve

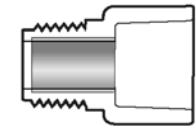

836-005R	1/2	25	150	086	3.65
836-007R	3/4	25	300	086	4.00
836-010R	1	10	60	086	7.01

**Special Reinforced Reducer Bushing**  
Mipt x SR Fipt - Stainless Steel Collar

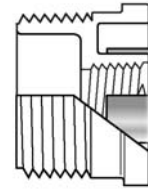

839-128SR	1X1/4	25	150	086	5.68
839-209SR	1-1/2X1/2	25	200	086	8.30
839-210SR	1-1/2X3/4	25	100	086	8.30
839-247SR	2X1/2	10	120	086	12.19
839-248SR	2X3/4	10	120	086	12.19
839-249SR	2X1	10	120	086	12.19
839-420SR	4X2	6	0	086	46.16

**Special Reinforced Reducer Bushing Flush Style**  
Spig x SR Fipt - Stainless Steel Collar

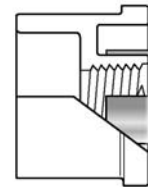

838-128SR	1X1/4	25	300	086	3.14
838-166SR	1-1/4X1/2	25	100	086	5.74
838-207SR	1-1/2X1/4	25	200	086	8.01
838-209SR	1-1/2X1/2	10	60	086	8.01
838-210SR	1-1/2X3/4	25	200	086	8.01
838-247SR	2X1/2	10	80	086	9.80
838-248SR	2X3/4	10	80	086	9.80
838-249SR	2X1	10	80	086	9.80

NOT FOR USE WITH COMPRESSED AIR OR GAS

Spears® Manufacturing Company

# PVC Gray Special Reinforced (SR) Fittings



Part Number	Size	Std Pk	Mstr Ctn	Disc Code	Price Each
-------------	------	--------	----------	-----------	------------

## Special Reinforced Reducer Bushing Flush Style

Spig x SR Fipt - Stainless Steel Collar (continued)

838-334SR	3X3/4	10	0	086	38.36
838-335SR	3X1	10	0	086	38.36
838-336SR	3X1-1/4	10	0	086	38.36
838-337SR	3X1-1/2	10	0	086	38.36
838-528SR	6X2	5	0	086	67.91
838-530SR	6X3	5	0	086	61.13
838-532SR	6X4	5	0	086	67.91

## Special Reinforced Cap SR Fipt - Stainless Steel Collar

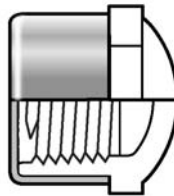

848-002SR	1/4	25	500	086	3.83
848-003SR	3/8	25	450	086	3.83
848-005SR	1/2	50	300	086	4.19
848-007SR	3/4	25	300	086	5.37
848-030SR	3	5	0	086	33.10

## Special Reinforced Union 2000 Soc x SR Fipt with EPDM O-ring Seal - Stainless Steel Collar

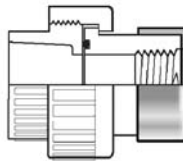

8099-005SR	1/2	20	160	086	7.60
8099-007SR	3/4	20	80	086	10.83
8099-010SR	1	15	90	086	13.97
8099-012SR	1-1/4	10	0	086	24.30
8099-015SR	1-1/2	10	0	086	31.49
8099-020SR	2	5	0	086	50.68
8099-025SR	2-1/2	5	0	086	108.41
8099-030SR	3	5	0	086	120.69
8099-040SR	4	4	0	086	137.74
8099-060SR	6	1	0	086	306.10

Part Number	Size	Std Pk	Mstr Ctn	Disc Code	Price Each
-------------	------	--------	----------	-----------	------------

## Special Reinforced Union 2000 Soc x SR Fipt with Viton® O-ring Seal - Stainless Steel Collar

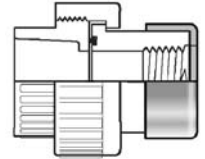

8059-005SR	1/2	20	160	086	7.90
8059-007SR	3/4	20	80	086	10.88
8059-010SR	1	15	90	086	14.14
8059-012SR	1-1/4	10	0	086	27.02
8059-015SR	1-1/2	10	0	086	33.34
8059-020SR	2	5	0	086	50.91
8059-025SR	2-1/2	5	0	086	109.43
8059-030SR	3	5	0	086	124.40
8059-040SR	4	4	0	086	142.83
8059-060SR	6	1	0	086	317.40

## Special Reinforced Union 2000 SR Fipt with EPDM O-ring Seal - Stainless Steel Collar

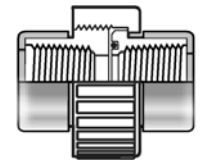

8098-005SR	1/2	20	120	086	8.01
8098-007SR	3/4	20	80	086	10.91
8098-010SR	1	15	90	086	14.44
8098-012SR	1-1/4	10	0	086	26.85
8098-015SR	1-1/2	10	0	086	33.77
8098-020SR	2	5	0	086	53.07
8098-025SR	2-1/2	5	0	086	107.11
8098-030SR	3	5	0	086	126.32
8098-040SR	4	4	0	086	145.02
8098-060SR	6	1	0	086	322.30

## Special Reinforced Union 2000 SR Fipt with Viton® O-ring Seal - Stainless Steel Collar

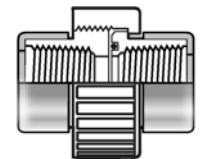

8058-005SR	1/2	20	120	086	8.13
8058-007SR	3/4	20	80	086	11.01
8058-010SR	1	15	90	086	14.73
8058-012SR	1-1/4	10	0	086	28.06
8058-015SR	1-1/2	10	0	086	34.53
8058-020SR	2	5	0	086	53.62
8058-025SR	2-1/2	5	0	086	112.12
8058-030SR	3	5	0	086	127.54

NOT FOR USE WITH COMPRESSED AIR OR GAS

Made in the U.S.A.

Page 10

Progressive Products from Spears® Innovation and Technology



# PVC Gray Special Reinforced (SR) Fittings

Part Number	Size	Std Pk	Mstr Ctn	Disc Code	Price Each
-------------	------	--------	----------	-----------	------------

**Special Reinforced Union 2000**  
**SR Fipt with Viton® O-ring Seal - Stainless Steel**  
**Collar (continued)**

8058-040SR	4	4	0	086	150.14
8058-060SR	6	1	0	086	333.63

**Special Reinforced Union (Old Style)**  
**Soc x SR Fipt with EPDM O-ring Seal - Stainless Steel Collar**

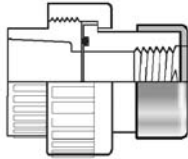

899-002SR	1/4	25	150	086	14.35
899-003SR	3/8	25	100	086	14.35
899-005SR	1/2	10	60	086	7.60
899-007SR	3/4	10	40	086	10.83
899-010SR	1	10	40	086	13.97
899-012SR	1-1/4	5	20	086	24.30
899-015SR	1-1/2	5	0	086	31.49
899-020SR	2	5	0	086	50.68
899-030SR	3	5	0	086	120.69
899-040SR	4	4	0	086	137.74

**Special Reinforced Union (Old Style)**  
**Soc x SR Fipt with Viton® O-ring Seal - Stainless Steel Collar**

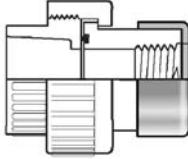

859-005SR	1/2	10	60	086	7.90
859-007SR	3/4	10	40	086	10.88
859-010SR	1	10	40	086	14.14
859-012SR	1-1/4	5	20	086	27.02
859-015SR	1-1/2	5	0	086	33.34
859-020SR	2	5	0	086	50.91
859-030SR	3	5	0	086	124.40
859-040SR	4	4	0	086	142.83

Part Number	Size	Std Pk	Mstr Ctn	Disc Code	Price Each
-------------	------	--------	----------	-----------	------------

**Special Reinforced Flange One Piece Threaded**  
**SR Fipt - Stainless Steel Collar**

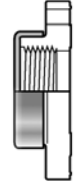

852-005SR	1/2	25	0	086	11.31
852-007SR	3/4	25	0	086	13.29
852-010SR	1	15	0	086	14.53
852-012SR	1-1/4	15	0	086	20.02
852-015SR	1-1/2	15	0	086	21.91
852-020SR	2	10	0	086	22.44
852-025SR	2-1/2	10	0	086	51.39
852-030SR	3	10	0	086	52.91
852-040SR	4	5	0	086	99.46

**PVC New Style Special Reinforced (SR) Threaded Tank Adapters with Neoprene Gaskets**  
**Soc x SR Fipt - Stainless Steel Collar**

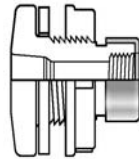

8171-002SR	1/4	25	150	100	33.80
8171-003SR	3/8	25	200	100	33.80
8171-005SR	1/2	25	0	100	33.80
8171-007SR	3/4	25	0	100	39.16
8171-010SR	1	25	0	100	44.10
8171-012SR	1-1/4	20	0	100	54.21
8171-015SR	1-1/2	20	0	100	62.22
8171-020SR	2	15	0	100	89.17
8171-025SR	2-1/2	4	0	100	143.57
8171-030SR	3	4	0	100	170.90
8171-040SR	4	2	0	100	316.12
8171-060SR	6	1	0	100	591.63

**PVC New Style Special Reinforced (SR) Threaded Tank Adapters with EPDM Gaskets**  
**Soc x SR Fipt - Stainless Steel Collar**

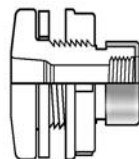

8171E-002SR	1/4	25	150	100	34.99
8171E-003SR	3/8	25	200	100	34.99
8171E-005SR	1/2	25	0	100	34.99
8171E-007SR	3/4	25	0	100	39.90
8171E-010SR	1	25	0	100	48.51

NOT FOR USE WITH COMPRESSED AIR OR GAS

# PVC Gray Special Reinforced (SR) Fittings



Part Number	Size	Std Pk	Mstr Ctn	Disc Code	Price Each
-------------	------	--------	----------	-----------	------------

**PVC New Style Special Reinforced (SR) Threaded Tank Adapters with EPDM Gaskets  
Soc x SR Fipt - Stainless Steel Collar (continued)**

8171E-012SR	1-1/4	20	0	100	58.77
8171E-015SR	1-1/2	20	0	100	66.79
8171E-020SR	2	15	0	100	95.34
8171E-025SR	2-1/2	4	0	100	148.23
8171E-030SR	3	4	0	100	176.47
8171E-040SR	4	2	0	100	323.55
8171E-060SR	6	1	0	100	611.98

Part Number	Size	Std Pk	Mstr Ctn	Disc Code	Price Each
-------------	------	--------	----------	-----------	------------

**PVC New Style Special Reinforced (SR) Threaded Tank Adapters with Neoprene Gaskets  
Fipt x SR Fipt - Stainless Steel Collar (continued)**

8172-015SR	1-1/2	20	0	100	83.97
8172-020SR	2	15	0	100	108.80
8172-025SR	2-1/2	4	0	100	165.65
8172-030SR	3	4	0	100	197.21
8172-040SR	4	2	0	100	351.09
8172-060SR	6	1	0	100	679.14

**PVC New Style Special Reinforced (SR) Threaded Tank Adapters with Viton® Gaskets  
Soc x SR Fipt - Stainless Steel Collar**

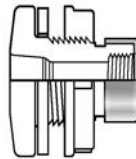

8171V-002SR	1/4	25	150	100	56.80
8171V-003SR	3/8	25	200	100	56.80
8171V-005SR	1/2	25	0	100	56.80
8171V-007SR	3/4	25	0	100	62.33
8171V-010SR	1	25	0	100	76.83
8171V-012SR	1-1/4	20	0	100	86.03
8171V-015SR	1-1/2	20	0	100	96.98
8171V-020SR	2	15	0	100	148.51
8171V-025SR	2-1/2	4	0	100	226.10
8171V-030SR	3	4	0	100	269.15
8171V-040SR	4	2	0	100	646.67
8171V-060SR	6	2	0	100	1146.10

**PVC New Style Special Reinforced (SR) Threaded Tank Adapters with EPDM Gaskets  
Fipt x SR Fipt - Stainless Steel Collar**

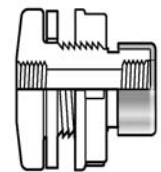

8172E-002SR	1/4	25	150	100	46.49
8172E-003SR	3/8	25	200	100	46.49
8172E-005SR	1/2	25	0	100	46.49
8172E-007SR	3/4	25	0	100	50.97
8172E-010SR	1	25	0	100	60.98
8172E-012SR	1-1/4	20	0	100	80.95
8172E-015SR	1-1/2	20	0	100	90.31
8172E-020SR	2	15	0	100	116.47
8172E-025SR	2-1/2	4	0	100	171.16
8172E-030SR	3	4	0	100	203.74
8172E-040SR	4	2	0	100	359.46
8172E-060SR	6	1	0	100	702.68

**PVC New Style Special Reinforced (SR) Threaded Tank Adapters with Neoprene Gaskets  
Fipt x SR Fipt - Stainless Steel Collar**

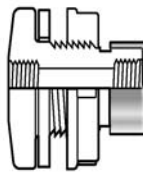

8172-002SR	1/4	25	150	100	45.19
8172-003SR	3/8	25	200	100	45.19
8172-005SR	1/2	25	0	100	45.19
8172-007SR	3/4	25	0	100	50.03
8172-010SR	1	25	0	100	55.33
8172-012SR	1-1/4	20	0	100	74.51

**PVC New Style Special Reinforced (SR) Threaded Tank Adapters with Viton® Gaskets  
Fipt x SR Fipt - Stainless Steel Collar**

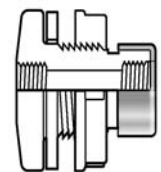

8172V-002SR	1/4	25	150	100	69.15
8172V-003SR	3/8	25	200	100	69.15
8172V-005SR	1/2	25	0	100	69.15
8172V-007SR	3/4	25	0	100	74.24
8172V-010SR	1	25	0	100	85.29
8172V-012SR	1-1/4	20	0	100	98.05
8172V-015SR	1-1/2	20	0	100	114.46

NOT FOR USE WITH COMPRESSED AIR OR GAS

Made in the U.S.A.

Progressive Products from Spears® Innovation and Technology

Page 12



# PVC Gray Special Reinforced (SR) Fittings

Part Number	Size	Std Pk	Mstr Ctn	Disc Code	Price Each
-------------	------	--------	----------	-----------	------------

**PVC New Style Special Reinforced (SR)  
Threaded Tank Adapters with Viton® Gaskets  
Fipt x SR Fipt - Stainless Steel Collar (continued)**

8172V-020SR	2	15	0	100	166.59
8172V-025SR	2-1/2	4	0	100	244.62
8172V-030SR	3	4	0	100	291.29
8172V-040SR	4	2	0	100	679.14
8172V-060SR	6	2	0	100	1282.40

**PVC Elastomer Expansion Joint  
with Neoprene Bellows SR Fipt -  
Stainless Steel Collar**



EJ01-007SR	3/4	10	0	085	190.59
EJ01-010SR	1	10	0	085	217.05
EJ01-012SR	1-1/4	15	0	085	236.07
EJ01-015SR	1-1/2	10	0	085	301.37
EJ01-020SR	2	8	0	085	362.07
EJ01-025SR	2-1/2	4	0	085	527.64
EJ01-030SR	3	2	0	085	709.59

**PVC Elastomer Expansion Joint  
with EPDM Bellows SR Fipt - Stainless  
Steel Collar**



EJ21-007SR	3/4	10	0	085	194.46
EJ21-010SR	1	10	0	085	221.48
EJ21-012SR	1-1/4	15	0	085	240.91
EJ21-015SR	1-1/2	10	0	085	307.50
EJ21-020SR	2	8	0	085	369.47
EJ21-025SR	2-1/2	4	0	085	535.41
EJ21-030SR	3	2	0	085	724.07

NOT FOR USE WITH COMPRESSED AIR OR GAS

# PVC Gray Brass Thread Fittings



Part Number	Size	Std Pk	Mstr Ctn	Disc Code	Price Each
-------------	------	--------	----------	-----------	------------

**Transition Tee  
Soc x Fipt With Brass Thread Insert**

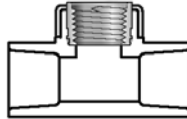

802-005BR	1/2	20	160	086	31.27
802-007BR	3/4	20	80	086	62.67
Not intended to convey or dispense water for human consumption through drinking or cooking					

**Transition Reducing Tee  
Soc x Fipt With Brass Thread Insert**

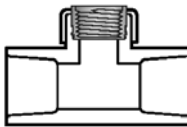

802-101BR	3/4X1/2	50	0	086	39.03
Not intended to convey or dispense water for human consumption through drinking or cooking					

**Transition 90° Ell  
Soc x Fipt With Brass Thread Insert**

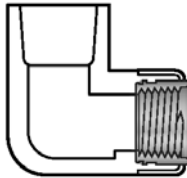

807-005BR	1/2	20	240	086	27.47
807-007BR	3/4	20	160	086	48.63
Not intended to convey or dispense water for human consumption through drinking or cooking					

**Transition Reducing 90° Ell  
Soc x Fipt With Brass Thread Insert**

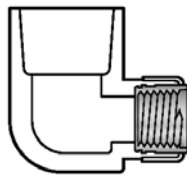

807-101BR	3/4X1/2	20	120	086	34.29
Not intended to convey or dispense water for human consumption through drinking or cooking					

Part Number	Size	Std Pk	Mstr Ctn	Disc Code	Price Each
-------------	------	--------	----------	-----------	------------

**Transition Female Adapter  
Soc x Fipt With Brass Thread Insert**

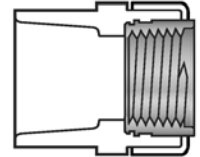

835-005BR	1/2	25	150	086	23.72
835-007BR	3/4	25	150	086	34.07
835-010BR	1	15	90	086	58.71
835-012BR	1-1/4	15	60	086	96.68
835-015BR	1-1/2	10	40	086	127.01
835-020BR	2	8	32	086	157.31
Not intended to convey or dispense water for human consumption through drinking or cooking					

**Transition Female Adapter  
Spig x Fipt With Brass Thread Insert**

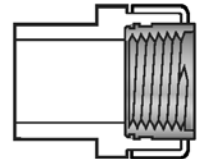

878-010BR	1	15	90	086	63.47
Not intended to convey or dispense water for human consumption through drinking or cooking					

**Transition Reducing Female Adapter  
Soc x Fipt With Brass Thread Insert**

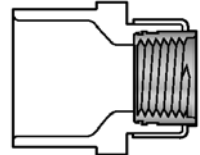

835-101BR	3/4X1/2	50	0	086	35.22
Not intended to convey or dispense water for human consumption through drinking or cooking					

**Transition Female Adapter  
Soc x Fipt With 316 Stainless Steel Thread Insert**

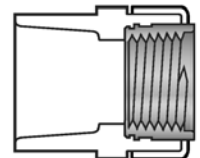

835-005SS	1/2	25	300	086	46.48
835-007SS	3/4	15	90	086	66.80
835-010SS	1	15	90	086	113.67
835-012SS	1-1/4	15	60	086	189.84
835-015SS	1-1/2	10	40	086	247.99
835-020SS	2	8	32	086	318.13



# PVC Gray Brass Thread Fittings

Part Number	Size	Std Pk	Mstr Ctn	Disc Code	Price Each
-------------	------	--------	----------	-----------	------------

**Transiton Male Adapter w/ Brass Thread**  
**Brass Mipt x Socket**



836-005BR	1/2	40	160	086	26.11
836-007BR	3/4	40	160	086	39.37
836-010BR	1	10	60	086	64.02
836-012BR	1-1/4	10	60	086	107.84
836-015BR	1-1/2	10	40	086	143.10
836-020BR	2	8	32	086	177.77

**Union**  
**Soc x Fipt with Brass Thread Insert & Viton® O-ring Seal**

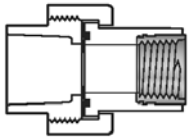

859-007BR	3/4	10	40	086	50.53
859-010BR	1	10	0	086	62.36
859-012BR	1-1/4	5	20	086	107.63
859-015BR	1-1/2	5	0	086	142.44
859-020BR	2	5	0	086	189.30

Not intended to convey or dispense water for human consumption through drinking or cooking

**Union**  
**Soc x Fipt with Brass Thread Insert & EPDM O-ring Seal**

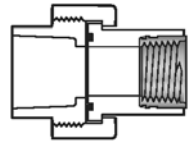

899-007BR	3/4	10	40	086	45.56
899-010BR	1	10	0	086	61.45
899-012BR	1-1/4	5	20	086	103.33
899-015BR	1-1/2	5	0	086	136.76
899-020BR	2	5	0	086	182.30

Not intended to convey or dispense water for human consumption through drinking or cooking

NOT FOR USE WITH COMPRESSED AIR OR GAS



# CPVC Gray Special Reinforced (SR) Fittings



Part Number	Size	Std Pk	Mstr Ctn	Disc Code	Price Each
-------------	------	--------	----------	-----------	------------

## Special Reinforced Tee Soc x SR Fipt - Stainless Steel Collar

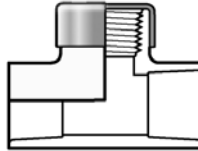

802-005CSR	1/2	50	0	096	18.69
802-007CSR	3/4	15	120	096	27.31
802-010CSR	1	15	0	096	34.36
802-012CSR	1-1/4	15	0	096	39.86
802-015CSR	1-1/2	10	0	096	39.86
802-030CSR	3	5	0	096	93.84
802-040CSR	4	5	0	096	176.79

## Special Reinforced Tee SR Fipt - Stainless Steel Collar

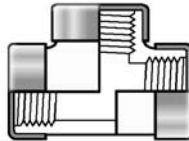

805-002CSR	1/4	20	160	096	16.72
805-003CSR	3/8	25	150	096	16.72
805-005CSR	1/2	25	150	096	22.37
805-007CSR	3/4	25	100	096	25.63
805-010CSR	1	15	0	096	38.28
805-015CSR	1-1/2	10	0	096	40.64
805-020CSR	2	10	0	096	48.39

## Special Reinforced Reducing Tee Soc x SR Fipt - Stainless Steel Collar

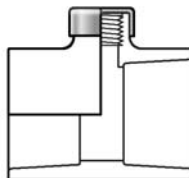

802-072CSR	1/2X1/4	25	200	096	18.69
802-098CSR	3/4X1/4	25	100	096	24.98
802-101CSR	3/4X1/2	50	0	096	24.98
802-128CSR <sup>1</sup>	1X1/4	15	0	096	38.57
802-130CSR	1X1/2	50	0	096	15.26
802-131CSR	1X3/4	15	0	086	38.57
802-164CSR <sup>1</sup>	1-1/4X1/4	5	0	096	51.29
802-166CSR	1-1/4X1/2	15	0	096	40.63
802-168CSR	1-1/4X1	10	0	096	41.46
802-207CSR <sup>1</sup>	1-1/2X1/4	15	0	096	73.44
802-211CSR	1-1/2X1	10	0	096	48.68
802-212CSR	1-1/2X1-1/4	10	0	096	48.68
802-245CSR <sup>1</sup>	2X1/4	10	0	096	84.36
802-247CSR	2X1/2	10	0	096	75.93
802-248CSR	2X3/4	10	0	096	84.36
802-287CSR	2-1/2X1/2	10	0	096	58.02

Part Number	Size	Std Pk	Mstr Ctn	Disc Code	Price Each
-------------	------	--------	----------	-----------	------------

## Special Reinforced Reducing Tee Soc x SR Fipt - Stainless Steel Collar (continued)

802-331CSR <sup>1</sup>	3X1/4	5	0	096	161.14
802-413CSR <sup>1</sup>	4X1/4	5	0	096	174.86

<sup>1</sup> Sized with Bushing

## Special Reinforced Reducing Tee Soc x SR Fipt - Stainless Steel Collar x Soc

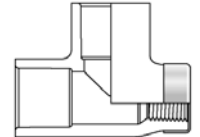

803-095CSR	3/4X1/2X3/4	15	0	096	15.39
------------	-------------	----	---	-----	-------

## Special Reinforced 90° Elbow Soc x SR Fipt - Stainless Steel Collar

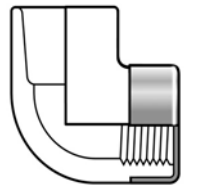

807-005CSR	1/2	20	240	096	9.07
807-007CSR	3/4	75	0	096	10.66
807-010CSR	1	50	0	096	12.83
807-012CSR	1-1/4	25	0	096	26.50
807-015CSR	1-1/2	10	0	090	31.85
807-020CSR	2	10	0	096	39.85

## Special Reinforced 90° Elbow SR Fipt - Stainless Steel Collar

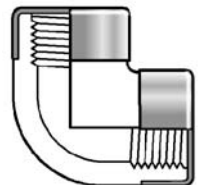

808-003CSR	3/8	25	150	096	5.48
808-005CSR	1/2	20	120	096	5.48
808-007CSR	3/4	20	160	096	8.03
808-010CSR	1	50	0	096	10.29
808-012CSR	1-1/4	25	0	096	19.80
808-015CSR	1-1/2	10	0	096	23.31
808-020CSR	2	10	0	096	31.23

NOT FOR USE WITH COMPRESSED AIR OR GAS

Made in the U.S.A.

Page 16

Progressive Products from Spears® Innovation and Technology



# CPVC Gray Special Reinforced (SR) Fittings

Part Number	Size	Std Pk	Mstr Ctn	Disc Code	Price Each
-------------	------	--------	----------	-----------	------------

**Special Reinforced Reducing 90° EII**  
**Soc x SR Fipt - Stainless Steel Collar**

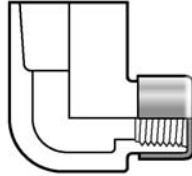

807-101CSR	3/4X1/2	50	0	096	11.56
807-130CSR	1X1/2	50	0	096	12.46

**Special Reinforced 45° EII SR Fipt - Stainless Steel Collar**

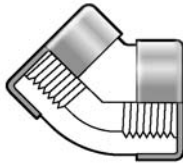

819-007CSR	3/4	10	120	096	12.53
------------	-----	----	-----	-----	-------

**Special Reinforced Coupling SR Fipt - Stainless Steel Collar**

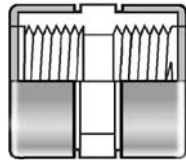

830-005CSR	1/2	25	300	096	8.84
830-007CSR	3/4	25	300	096	14.29
830-010CSR	1	25	200	096	16.23
830-012CSR	1-1/4	10	120	096	17.24
830-015CSR	1-1/2	10	80	096	18.49
830-020CSR	2	10	0	096	21.85

**Special Reinforced Reducer Coupling SR Fipt - Stainless Steel Collar**

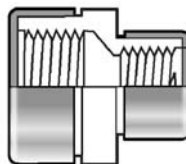

830-101CSR	3/4X1/2	50	200	096	15.85
830-130CSR	1X1/2	50	0	096	19.13
830-131CSR	1X3/4	25	200	096	19.13
830-168CSR	1-1/4X1	25	0	096	26.02
830-210CSR	1-1/2X3/4	25	0	096	37.21
830-211CSR	1-1/2X1	10	80	096	37.21
830-212CSR	1-1/2X1-1/4	10	80	096	37.21
830-249CSR	2X1	25	0	096	91.60
830-251CSR	2X1-1/2	15	0	096	91.60

Part Number	Size	Std Pk	Mstr Ctn	Disc Code	Price Each
-------------	------	--------	----------	-----------	------------

**Special Reinforced Female Adapter Soc x SR Fipt - Stainless Steel Collar**

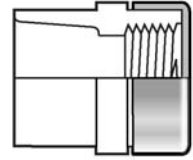

835-002CSR	1/4	25	450	096	12.41
835-003CSR	3/8	25	300	096	12.41
835-005CSR	1/2	25	300	096	5.33
835-007CSR	3/4	25	150	096	5.76
835-010CSR	1	25	200	096	13.13
835-012CSR	1-1/4	10	60	096	13.47
835-015CSR	1-1/2	10	80	096	15.64
835-020CSR	2	10	0	096	22.22
835-025CSR	2-1/2	5	0	096	51.67
835-030CSR	3	15	0	096	106.16
835-040CSR	4	5	0	096	176.69
835-060CSR	6	6	0	096	276.02

**Encapsulated Special Reinforced (SR) Female Adapter Soc x ESR Fipt**

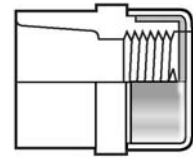

835-002CESR	1/4	25	450	096	15.74
835-003CESR	3/8	25	300	096	15.74
835-005CESR	1/2	25	300	096	8.17
835-007CESR	3/4	25	300	096	8.63
835-010CESR	1	25	200	096	19.01
835-012CESR	1-1/4	10	80	096	19.46
835-015CESR	1-1/2	10	0	096	25.19
835-020CESR	2	10	0	096	39.16

**Special Reinforced Spigot Female Adapter Spig x SR Fipt - Stainless Steel Collar**

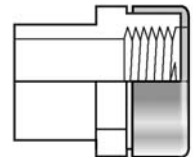

878-005CSR	1/2	50	600	096	5.68
878-007CSR	3/4	25	300	096	5.99
878-010CSR	1	50	0	096	13.48
878-012CSR	1-1/4	25	0	096	13.95
878-015CSR	1-1/2	25	0	096	16.19
878-020CSR	2	15	0	096	29.49
878-030CSR	3	5	0	096	107.49
878-040CSR	4	5	0	096	180.45

NOT FOR USE WITH COMPRESSED AIR OR GAS

# CPVC Gray Special Reinforced (SR) Fittings



Part Number	Size	Std Pk	Mstr Ctn	Disc Code	Price Each
-------------	------	--------	----------	-----------	------------

## Special Reinforced Reducing Female Adapter Soc x SR Fipt - Stainless Steel Collar

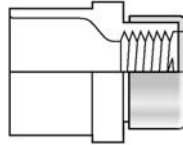

835-074CSR	1/2X3/4	50	400	096	5.76
835-101CSR	3/4X1/2	50	400	096	5.76
835-102CSR	3/4X1	50	0	096	13.13
835-130CSR	1X1/2	50	0	096	13.13
835-131CSR	1X3/4	25	200	096	13.13

## Encapsulated Special Reinforced (SR) Female Adapter Spig x ESR Fipt

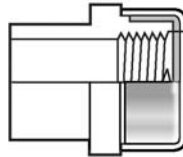

878-005CESR	1/2	50	600	096	8.41
878-007CESR	3/4	25	300	096	8.95
878-010CESR	1	50	0	096	19.19
878-012CESR	1-1/4	25	0	096	19.71
878-015CESR	1-1/2	25	0	096	25.70
878-020CESR	2	15	0	096	39.72

## Special Reinforced Reducing Spigot Female Adapter Spig x SR Fipt - Stainless Steel Collar

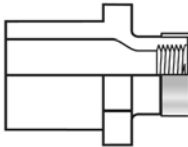

878-072CSR	1/2X1/4	25	450	096	16.28
878-098CSR	3/4X1/4	50	400	096	18.95
878-128CSR	1X1/4	50	400	096	21.21

## Reinforced Male Adapter R Mipt x Soc - Stainless Steel Sleeve

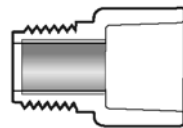

836-005CR	1/2	25	150	096	8.19
836-007CR	3/4	25	300	096	9.38
836-010CR	1	10	120	096	11.12

Part Number	Size	Std Pk	Mstr Ctn	Disc Code	Price Each
-------------	------	--------	----------	-----------	------------

## Special Reinforced Reducing Bushing Mipt x SR Fipt - Stainless Steel Collar

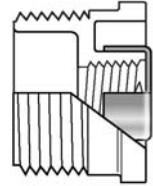

839-209CSR	1-1/2X1/2	25	200	096	21.00
839-210CSR	1-1/2X3/4	25	100	096	21.00
839-247CSR	2X1/2	10	120	096	23.21
839-248CSR	2X3/4	10	120	096	23.21
839-249CSR	2X1	10	120	096	23.21
839-420CSR	4X2	6	0	096	128.88

## Special Reinforced Reducer Bushing Spig x SR Fipt - Stainless Steel Collar

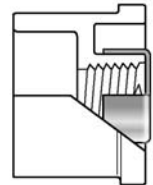

838-128CSR	1X1/4	25	150	096	12.10
838-207CSR	1-1/2X1/4	25	200	096	20.47
838-209CSR	1-1/2X1/2	10	120	096	21.34
838-210CSR	1-1/2X3/4	10	120	096	21.34
838-247CSR	2X1/2	10	80	096	29.32
838-248CSR	2X3/4	10	80	096	29.32
838-249CSR	2X1	10	80	096	29.32
838-334CSR	3X3/4	10	0	096	124.15
838-335CSR	3X1	10	0	096	124.15
838-336CSR	3X1-1/4	10	0	096	124.15
838-337CSR	3X1-1/2	10	0	096	124.15
838-528CSR	6X2	5	0	096	426.81
838-530CSR	6x3	5	0	096	426.81

## Special Reinforced Cap SR Fipt - Stainless Steel Collar

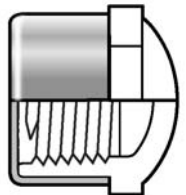

848-002CSR	1/4	25	500	096	6.71
848-003CSR	3/8	25	450	096	6.71
848-007CSR	3/4	25	300	096	10.45
848-030CSR	3	5	0	096	116.66

NOT FOR USE WITH COMPRESSED AIR OR GAS

Made in the U.S.A.

Progressive Products from Spears® Innovation and Technology

Page 18



# CPVC Gray Special Reinforced (SR) Fittings

Part Number	Size	Std Pk	Mstr Ctn	Disc Code	Price Each
-------------	------	--------	----------	-----------	------------

**Special Reinforced Union 2000**  
**Soc x SR Fipt with EPDM O-ring Seal -**  
**Stainless Steel Collar**

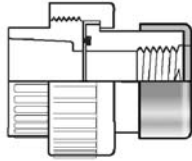

8099-005CSR	1/2	20	160	096	15.02
8099-007CSR	3/4	20	160	096	26.67
8099-010CSR	1	15	90	096	36.93
8099-012CSR	1-1/4	10	0	096	69.96
8099-015CSR	1-1/2	10	0	096	76.09
8099-020CSR	2	5	0	096	80.12
8099-025CSR	2-1/2	5	0	096	137.43
8099-030CSR	3	5	0	096	223.20
8099-040CSR	4	4	0	096	262.13
8099-060CSR	6	1	0	096	582.54

**Special Reinforced Union 2000**  
**SR Fipt with Viton® O-ring Seal -**  
**Stainless Steel Collar**

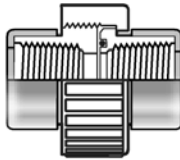

8058-005CSR	1/2	20	160	096	15.72
8058-007CSR	3/4	20	80	096	27.41
8058-010CSR	1	15	90	096	37.67
8058-012CSR	1-1/4	10	0	096	71.00
8058-015CSR	1-1/2	10	0	096	77.48
8058-020CSR	2	5	0	096	81.64
8058-030CSR	3	5	0	096	230.71
8058-040CSR	4	4	0	096	270.28
8058-060CSR	6	1	0	096	608.69

**Special Reinforced Union 2000**  
**SR Fipt with EPDM O-ring Seal -**  
**Stainless Steel Collar**

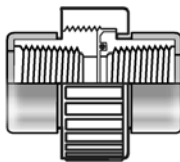

8098-005CSR	1/2	20	160	096	15.20
8098-007CSR	3/4	20	80	096	27.16
8098-010CSR	1	15	90	096	37.24
8098-012CSR	1-1/4	10	0	096	70.31
8098-015CSR	1-1/2	10	0	096	76.88
8098-020CSR	2	5	0	096	80.84
8098-025CSR	2-1/2	5	0	096	139.70
8098-030CSR	3	5	0	096	227.14
8098-040CSR	4	4	0	096	262.95

Part Number	Size	Std Pk	Mstr Ctn	Disc Code	Price Each
-------------	------	--------	----------	-----------	------------

**Special Reinforced Union 2000**  
**SR Fipt with EPDM O-ring Seal - Stainless Steel**  
**Collar (continued)**

8098-060CSR	6	1	0	096	584.34
-------------	---	---	---	-----	--------

**Special Reinforced Union (Old Style)**  
**Soc x SR Fipt with EPDM O-ring Seal -**  
**Stainless Steel Collar**

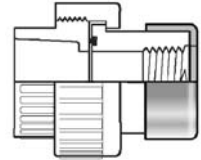

899-002CSR	1/4	25	150	096	23.95
899-003CSR	3/8	25	100	096	23.95
899-005CSR	1/2	10	60	096	15.02
899-007CSR	3/4	10	40	096	26.67
899-010CSR	1	10	40	096	36.93
899-012CSR	1-1/4	5	20	096	69.96
899-015CSR	1-1/2	5	0	096	76.09
899-020CSR	2	5	0	096	80.12
899-030CSR	3	5	0	096	223.20
899-040CSR	4	4	0	096	262.13

**Special Reinforced Union (Old Style)**  
**Soc x SR Fipt with Viton® O-ring Seal -**  
**Stainless Steel Collar**

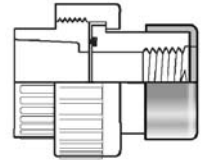

859-002CSR	1/4	25	150	096	24.11
859-003CSR	3/8	25	100	096	24.11
859-005CSR	1/2	10	60	096	15.32
859-007CSR	3/4	10	40	096	27.03
859-010CSR	1	10	40	096	37.24
859-012CSR	1-1/4	5	20	096	71.00
859-015CSR	1-1/2	5	0	096	77.18
859-020CSR	2	5	0	096	80.35
859-030CSR	3	5	0	096	226.04
859-040CSR	4	4	0	096	263.72

NOT FOR USE WITH COMPRESSED AIR OR GAS

# CPVC Gray Special Reinforced (SR) Fittings



Part Number	Size	Std Pk	Mstr Ctn	Disc Code	Price Each
-------------	------	--------	----------	-----------	------------

## Special Reinforced Flange One Piece Threaded SR Fipt - Stainless Steel Collar



852-005CSR	1/2	25	0	096	19.62
852-007CSR	3/4	25	0	096	23.80
852-010CSR	1	15	0	096	26.04
852-012CSR	1-1/4	15	0	096	36.03
852-015CSR	1-1/2	15	0	096	38.20
852-020CSR	2	10	0	096	39.13
852-025CSR	2-1/2	10	0	090	62.96
852-030CSR	3	10	0	096	62.47
852-040CSR	4	5	0	096	97.06

## CPVC New Style Special Reinforced (SR) Threaded Tank Adapters with Neoprene Gaskets Soc x SR Fipt - Stainless Steel Collar

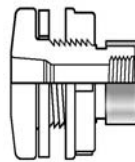

8171-002CSR	1/4	25	150	101	47.31
8171-003CSR	3/8	25	200	101	47.31
8171-005CSR	1/2	25	0	101	47.31
8171-007CSR	3/4	25	0	101	56.62
8171-010CSR	1	25	0	101	64.05
8171-012CSR	1-1/4	20	0	101	82.62
8171-015CSR	1-1/2	20	0	101	92.76
8171-020CSR	2	15	0	101	128.27
8171-025CSR	2-1/2	4	0	101	195.12
8171-030CSR	3	4	0	101	232.24
8171-040CSR	4	2	0	101	373.24
8171-060CSR	6	1	0	101	985.77

## CPVC New Style Special Reinforced (SR) Threaded Tank Adapters with EPDM Gaskets Soc x SR Fipt - Stainless Steel Collar

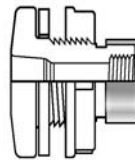

8171E-002CSR	1/4	25	150	101	53.62
8171E-003CSR	3/8	25	200	101	53.62
8171E-005CSR	1/2	25	0	101	53.62
8171E-007CSR	3/4	25	0	101	60.60
8171E-010CSR	1	25	0	101	72.46
8171E-012CSR	1-1/4	20	0	101	90.55
8171E-015CSR	1-1/2	20	0	101	97.97

Part Number	Size	Std Pk	Mstr Ctn	Disc Code	Price Each
-------------	------	--------	----------	-----------	------------

## CPVC New Style Special Reinforced (SR) Threaded Tank Adapters with EPDM Gaskets Soc x SR Fipt - Stainless Steel Collar (continued)

8171E-020CSR	2	15	0	101	138.50
8171E-025CSR	2-1/2	4	0	101	203.53
8171E-030CSR	3	4	0	101	242.30
8171E-040CSR	4	2	0	101	388.48
8171E-060CSR	6	2	0	101	1025.93

## CPVC New Style Special Reinforced (SR) Threaded Tank Adapters with Viton® Gaskets Soc x SR Fipt - Stainless Steel Collar

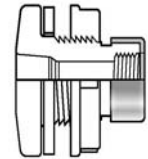

8171V-002CSR	1/4	25	150	101	69.86
8171V-003CSR	3/8	25	200	101	69.86
8171V-005CSR	1/2	25	0	101	69.86
8171V-007CSR	3/4	25	0	101	80.76
8171V-010CSR	1	25	0	101	93.95
8171V-012CSR	1-1/4	20	0	101	116.46
8171V-015CSR	1-1/2	20	0	101	124.36
8171V-020CSR	2	15	0	101	185.18
8171V-025CSR	2-1/2	4	0	101	272.90
8171V-030CSR	3	4	0	101	324.95
8171V-040CSR	4	2	0	101	693.84
8171V-060CSR	6	2	0	101	1713.06

## CPVC New Style Special Reinforced (SR) Threaded Tank Adapters with Neoprene Gaskets Fipt x SR Fipt - Stainless Steel Collar

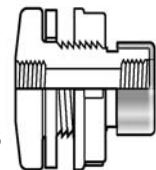

8172-002CSR	1/4	25	150	101	62.67
8172-003CSR	3/8	25	200	101	62.67
8172-005CSR	1/2	25	0	101	62.67
8172-007CSR	3/4	25	0	101	72.78
8172-010CSR	1	25	0	101	80.19
8172-012CSR	1-1/4	20	0	101	113.76
8172-015CSR	1-1/2	20	0	101	127.09
8172-020CSR	2	15	0	101	157.13
8172-025CSR	2-1/2	4	0	101	228.05
8172-030CSR	3	4	0	101	271.49

NOT FOR USE WITH COMPRESSED AIR OR GAS

Made in the U.S.A.

Progressive Products from Spears® Innovation and Technology

Page 20



# CPVC Gray Special Reinforced (SR) Fittings

Part Number	Size	Std Pk	Mstr Ctn	Disc Code	Price Each
-------------	------	--------	----------	-----------	------------

**CPVC New Style Special Reinforced (SR) Threaded Tank Adapters with Neoprene Gaskets**

**Fipt x SR Fipt - Stainless Steel Collar (continued)**

8172-040CSR	4	2	0	101	416.98
8172-060CSR	6	2	0	101	1117.17

**CPVC New Style Special Reinforced (SR) Threaded Tank Adapters with EPDM Gaskets**  
**Fipt x SR Fipt - Stainless Steel Collar**

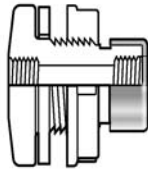

8172E-002CSR	1/4	25	150	101	65.12
8172E-003CSR	3/8	25	200	101	65.12
8172E-005CSR	1/2	25	0	101	65.12
8172E-007CSR	3/4	25	0	101	77.11
8172E-010CSR	1	25	0	101	83.71
8172E-012CSR	1-1/4	20	0	101	118.16
8172E-015CSR	1-1/2	20	0	101	137.37
8172E-020CSR	2	15	0	101	168.61
8172E-025CSR	2-1/2	4	0	101	254.35
8172E-030CSR	3	4	0	101	302.79
8172E-040CSR	4	2	0	101	490.19
8172E-060CSR	6	2	0	101	1133.70

**CPVC New Style Special Reinforced (SR) Threaded Tank Adapters with Viton® Gaskets**  
**Fipt x SR Fipt - Stainless Steel Collar**

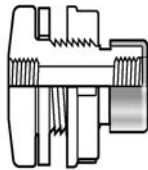

8172V-002CSR	1/4	25	150	101	100.00
8172V-003CSR	3/8	25	200	101	100.00
8172V-005CSR	1/2	25	0	101	100.00
8172V-007CSR	3/4	25	0	101	113.13
8172V-010CSR	1	25	0	101	130.65
8172V-012CSR	1-1/4	20	0	101	161.31
8172V-015CSR	1-1/2	20	0	101	169.89
8172V-020CSR	2	15	0	101	261.10
8172V-025CSR	2-1/2	4	0	101	377.28
8172V-030CSR	3	4	0	101	449.15
8172V-040CSR	4	2	0	101	1146.09
8172V-060CSR	6	2	0	101	2081.00

Part Number	Size	Std Pk	Mstr Ctn	Disc Code	Price Each
-------------	------	--------	----------	-----------	------------

**CPVC Elastomer Expansion Joint**

**with EPDM Bellows SR Fipt - Stainless Steel Collar**



EJ21-007CSR	3/4	10	0	085	197.81
EJ21-010CSR	1	10	0	085	227.48
EJ21-012CSR	1-1/4	15	0	085	251.37
EJ21-015CSR	1-1/2	10	0	085	320.41
EJ21-020CSR	2	8	0	085	423.52
EJ21-025CSR	2-1/2	4	0	085	588.17
EJ21-030CSR	3	2	0	085	783.37

NOT FOR USE WITH COMPRESSED AIR OR GAS

# CPVC Gray Brass Thread Fittings



Part Number	Size	Std Pk	Mstr Ctn	Disc Code	Price Each
-------------	------	--------	----------	-----------	------------

## Transition Tee Soc x Fipt With Brass Thread Insert

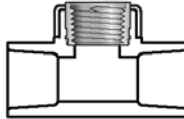

802-005CBR	1/2	20	160	096	55.46
802-007CBR	3/4	25	0	096	110.91
Not intended to convey or dispense water for human consumption through drinking or cooking					

## Transition Reducing Tee Soc x Fipt With Brass Thread Insert

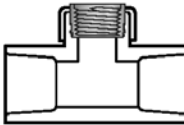

802-101CBR	3/4X1/2	50	0	096	68.74
Not intended to convey or dispense water for human consumption through drinking or cooking					

## Transition 90° Ell Soc x Fipt With Brass Thread Insert

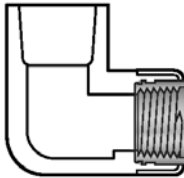

807-005CBR	1/2	20	240	096	48.76
807-007CBR	3/4	20	160	096	85.13
Not intended to convey or dispense water for human consumption through drinking or cooking					

## Transition Reducing 90° Ell Soc x Fipt With Brass Thread Insert

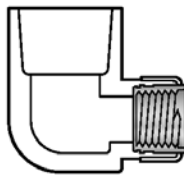

807-101CBR	3/4X1/2	20	120	096	60.98
Not intended to convey or dispense water for human consumption through drinking or cooking					

Part Number	Size	Std Pk	Mstr Ctn	Disc Code	Price Each
-------------	------	--------	----------	-----------	------------

## Transition Female Adapter Soc x Fipt With Brass Thread Insert

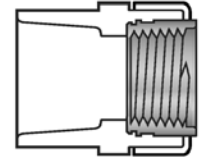

835-005CBR	1/2	25	150	096	30.06
835-007CBR	3/4	15	90	096	62.21
835-010CBR	1	15	90	096	109.17
835-012CBR	1-1/4	15	60	096	178.10
835-015CBR	1-1/2	10	80	096	234.82
835-020CBR	2	8	32	096	293.28

Not intended to convey or dispense water for human consumption through drinking or cooking

## Transition Female Adapter Soc x Fipt With Type 316 Stainless Steel Thread Insert

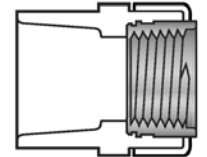

835-005CSS	1/2	25	150	096	59.02
835-007CSS	3/4	15	90	096	82.40
835-010CSS	1	15	90	096	144.22
835-012CSS	1-1/4	15	0	096	234.38
835-015CSS	1-1/2	10	60	096	305.78
835-020CSS	2	8	32	096	357.85

## Transition Male Adapter w/Brass Thread Brass Mipt x Socket



836-005CBR	1/2	40	160	096	66.63
836-007CBR	3/4	40	160	096	93.81
836-010CBR	1	10	60	096	163.39
836-012CBR	1-1/4	10	60	096	265.77
836-015CBR	1-1/2	10	40	096	345.52
836-020CBR	2	8	32	096	404.89

## Union Soc x Fipt with Brass Thread Insert & Viton® O-ring Seal

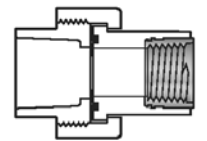

859-007CBR	3/4	10	20	096	138.86
859-010CBR	1	10	0	096	154.66

NOT FOR USE WITH COMPRESSED AIR OR GAS

Made in the U.S.A.

Progressive Products from Spears® Innovation and Technology

Page 22



# CPVC Gray Brass Thread Fittings

Part Number	Size	Std Pk	Mstr Ctn	Disc Code	Price Each
-------------	------	-----------	-------------	--------------	---------------

**Union**  
**Soc x Fipt with Brass Thread Insert & Viton® O-ring**  
**Seal (continued)**

859-012CBR	1-1/4	5	0	096	259.26
859-015CBR	1-1/2	5	0	096	294.62
859-020CBR	2	5	0	096	332.98

Not intended to convey or dispense water for human consumption through drinking or cooking

**Union**  
**Soc x Fipt with Brass Thread Insert &**  
**EPDM O-ring Seal**

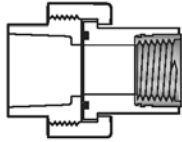

899-007CBR	3/4	10	40	096	136.51
899-010CBR	1	10	0	096	152.76
899-012CBR	1-1/4	5	20	096	255.99
899-015CBR	1-1/2	5	0	096	290.86
899-020CBR	2	5	0	096	328.90

Not intended to convey or dispense water for human consumption through drinking or cooking

NOT FOR USE WITH COMPRESSED AIR OR GAS

Spears® Manufacturing Company



# CPVC Orange Special Reinforced (SR) Fittings



The CPVC Orange fittings in this section (4200 series part numbers) are approved by Underwriters Laboratories, FM Global, and LPCB for use in CPVC Fire Sprinkler Systems. When installed in these systems, installation must be made in accordance with Spears® publication FG-3, *FlameGuard® CPVC Fire Sprinkler Products Installation Instructions*, and local codes. However, these fittings can also be used in many other types of installations, such as hot water distribution. CPVC fittings may also be used on PVC pipe when installed with a quality CPVC solvent cement meeting the requirements of ASTM F 493, Standard Specification for Solvent Cements for Chlorinated Poly(Vinyl Chloride)(CPVC) Plastic Pipe and Fittings.

Part Number	Size	Std Pk	Mstr Ctn	Disc Code	Price Each
-------------	------	--------	----------	-----------	------------

**Sprinkler Head Tee - Special Reinforced Plastic Thread Style with Wrench Flats**  
Socket x Socket x SR FIPT - Zinc Collar

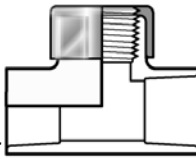

4202-010SR	1	15	0	076	19.38
4202-130SR	1X1/2	50	0	076	7.55

**Sprinkler Head Tee - Special Reinforced Plastic Thread Style**  
Socket x Socket x SR FIPT - Stainless Steel Collar

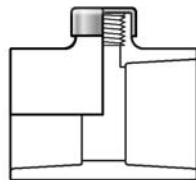

4202-101SR	3/4X1/2	50	0	076	6.99
4202-124SR	1X3/4X1/2	50	0	076	7.55
4202-156SR	1-1/4X1X1/2	15	0	076	12.59
4202-166SR	1-1/4X1/2	15	0	076	12.59
4202-168SR	1-1/4X1	15	0	076	27.06
4202-199SR	1-1/2X1-1/4X1/2	10	0	076	16.57
4202-209SR	1-1/2X1/2	25	0	076	16.57
4202-211SR	1-1/2X1-1/2X1	10	0	076	16.57
4202-237SR	2X1-1/2X1/2	10	0	076	23.38
4202-247SR	2X1/2	10	0	076	23.38
4202-287SR	2-1/2X1/2	10	0	076	32.04

**Sprinkler Head Tee - Special Reinforced Plastic Thread Style**  
Socket x SR FIPT x Socket - Stainless Steel Collar

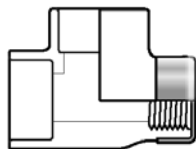

4203-122SR	1X1/2X1	50	0	076	8.11
------------	---------	----	---	-----	------

Part Number	Size	Std Pk	Mstr Ctn	Disc Code	Price Each
-------------	------	--------	----------	-----------	------------

**Sprinkler Head 90° Ell - Special Reinforced Plastic Thread Style**  
Socket x SR FIPT - Stainless Steel Collar

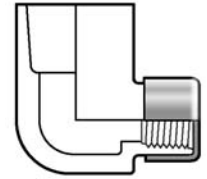

4207-101SR	3/4X1/2	20	180	076	4.61
4207-130SR	1X1/2	10	150	076	6.50
4207-131SR	1X3/4	50	0	076	7.86
4207-166SR	1-1/4X1/2	25	0	076	8.26

**Female Adapter - Special Reinforced Plastic Thread Style**  
Socket x SR FIPT - Stainless Steel Collar

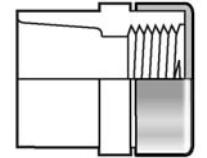

4235-007SR	3/4	25	300	076	8.22
4235-010SR <sup>1</sup>	1	25	200	076	14.45
4235-012SR	1-1/4	10	60	076	23.52

1-Zinc Collar

**Female Sprinkler Head Adapter - Special Reinforced Plastic Thread Style**  
Socket x SR FIPT - Stainless Steel Collar

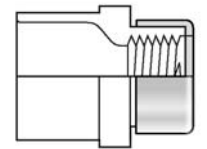

4235-101SR	3/4X1/2	50	200	076	5.02
4235-130SR	1X1/2	50	0	076	5.37
4235-131SR	1X3/4	50	0	076	8.50

**Female Sprinkler Head Adapter - Special Reinforced Plastic Thread Style with Socket Body Wrench Flats**  
Socket x SR FIPT - Stainless Steel Collar

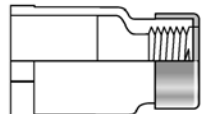

W4235-101SR	3/4X1/2	50	0	076	5.73
W4235-130SR	1X1/2	50	0	076	6.13

NOT FOR USE WITH COMPRESSED AIR OR GAS

Made in the U.S.A.

Progressive Products from Spears® Innovation and Technology

Page 24



# CPVC Orange Special Reinforced (SR) Fittings

Part Number	Size	Std Pk	Mstr Ctn	Disc Code	Price Each
-------------	------	--------	----------	-----------	------------

**Female Sprinkler Head Adapter - Special Reinforced Plastic Thread with Metal Thread Start Socket x SR FIPT - Zinc Collar**

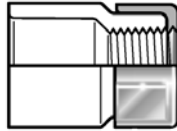

Z4235-101SR	3/4X1/2	50	200	076	5.02
Z4235-130SR	1X1/2	50	0	076	5.37

Part Number	Size	Std Pk	Mstr Ctn	Disc Code	Price Each
-------------	------	--------	----------	-----------	------------

**Spigot Female Adapter - Special Reinforced Plastic Thread Style Spigot x SR FIPT - Stainless Steel Collar**

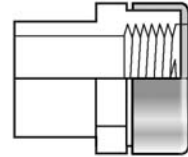

4278-007SR	3/4	25	300	076	8.63
4278-010SR	1	50	0	076	15.36

**Female Sprinkler Head Adapter - Special Reinforced Plastic Thread Style with Positioning Ring Socket x SR FIPT - Stainless Steel Collar**

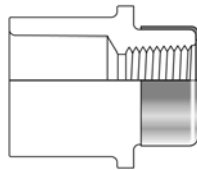

R4235-101SR	3/4X1/2	25	300	076	5.67
-------------	---------	----	-----	-----	------

**Spigot Female Sprinkler Head Adapters - Special Reinforced Plastic Threaded Style Spigot x SR FIPT - Stainless Steel Collar**

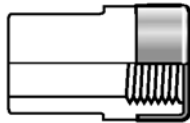

4238-101SR	3/4X1/2	50	400	076	5.02
4238-130SR	1X1/2	50	0	076	5.43

**Adjustable Sprinkler Head Adapters - Special Reinforced Plastic Thread Style Socket x SR FIPT - Zinc Collar**



42001SR	3/4X1/2	12	0	076	12.82
42011SR	1X1/2	12	0	076	12.82

**Adjustable Sprinkler Head Adapters - Special Reinforced Plastic Thread Style Spigot x SR FIPT - Zinc Collar**



42004SR	3/4X1/2	12	0	076	12.82
42014SR	1X1/2	12	0	076	12.82

NOT FOR USE WITH COMPRESSED AIR OR GAS

# CPVC Orange Brass Thread Fittings



The CPVC Orange fittings in this section (4200 series part numbers) are approved by Underwriters Laboratories, FM Global, and LPCB for use in CPVC Fire Sprinkler Systems. When installed in these systems, installation must be made in accordance with Spears® publication FG-3, *FlameGuard® CPVC Fire Sprinkler Products Installation Instructions*, and local codes. However, these fittings can also be used in many other types of installations, such as hot water distribution. CPVC fittings may also be used on PVC pipe when installed with a quality CPVC solvent cement meeting the requirements of ASTM F 493, Standard Specification for Solvent Cements for Chlorinated Poly(Vinyl Chloride)(CPVC) Plastic Pipe and Fittings.

Part Number	Size	Std Pk	Mstr Ctn	Disc Code	Price Each
-------------	------	--------	----------	-----------	------------

### Sprinkler Head Tee - Brass Thread Insert Style Socket x Socket x FIPT

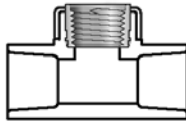

4202-101	3/4X1/2	50	0	076	13.14
4202-124	1X3/4X1/2	50	0	076	14.18
4202-130	1X1/2	50	0	076	14.18
4202-010	1	10	40	076	36.47
4202-156	1-1/4X1X1/2	15	0	076	23.65
4202-166	1-1/4X1/2	15	0	076	23.65
4202-199	1-1/2X1-1/4X1/2	10	0	076	31.15
4202-209	1-1/2X1/2	10	0	076	31.15
4202-237	2X1-1/2X1/2	10	0	076	43.93
4202-247	2X1/2	10	0	076	43.93

Not intended to convey or dispense water for human consumption through drinking or cooking

### Sprinkler Head Tee - Brass Thread Insert Style Socket x FIPT x Socket

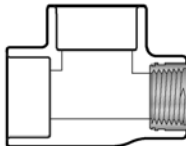

4203-122	1X1/2X1	50	0	076	23.29
----------	---------	----	---	-----	-------

Not intended to convey or dispense water for human consumption through drinking or cooking

### Sprinkler Head 90° Ell - Brass Thread Insert Style Socket x FIPT

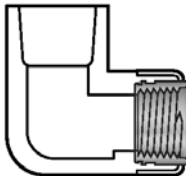

4207-101	3/4X1/2	20	120	076	8.68
4207-130	1X1/2	15	90	076	12.20
4207-131	1X3/4	25	0	076	14.76
4207-166	1-1/4X1/2	10	60	076	16.99

Not intended to convey or dispense water for human consumption through drinking or cooking

Part Number	Size	Std Pk	Mstr Ctn	Disc Code	Price Each
-------------	------	--------	----------	-----------	------------

### Female Adapter - Brass Thread Insert Style Socket x FIPT

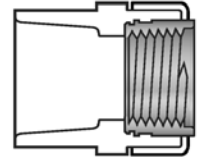

4235-007	3/4	15	90	076	17.32
4235-010	1	15	90	076	30.39
4235-012	1-1/4	15	60	076	49.54
4235-015	1-1/2	10	40	076	66.09
4235-020	2	8	32	076	82.83

Not intended to convey or dispense water for human consumption through drinking or cooking

### Spigot Female Adapter - Brass Thread Insert Style Spigot x FIPT

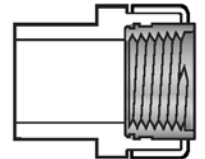

4278-007	3/4	25	150	076	16.20
4278-010	1	15	90	076	28.85

Not intended to convey or dispense water for human consumption through drinking or cooking

### TorqueSafe™ Female Sprinkler Head Adapter - Gasket Sealed Brass Thread Insert Style Socket x Gasket FIPT

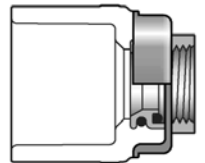

4235-130GS	1X1/2	50	0	076	10.10
------------	-------	----	---	-----	-------

FIPT With Elastomer Seal - Use NO Thread Sealant

Not intended to convey or dispense water for human consumption through drinking or cooking

NOT FOR USE WITH COMPRESSED AIR OR GAS

Made in the U.S.A.

Progressive Products from Spears® Innovation and Technology

Page 26



# CPVC Orange Brass Thread Fittings

Part Number	Size	Std Pk	Mstr Ctn	Disc Code	Price Each
-------------	------	--------	----------	-----------	------------

**Female Sprinkler Head Adapter - Brass Thread Insert Style**  
Socket x FIPT

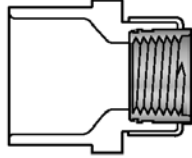

4235-101	3/4X1/2	50	0	076	9.46
4235-130	1X1/2	50	0	076	10.10
4235-131	1X3/4	50	0	076	15.96

Not intended to convey or dispense water for human consumption through drinking or cooking

Part Number	Size	Std Pk	Mstr Ctn	Disc Code	Price Each
-------------	------	--------	----------	-----------	------------

**Bushing - with Brass Thread Insert**  
Spigot x FIPT

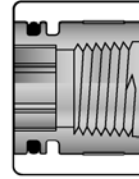

4238-130BR	1X1/2	50	300	076	13.07
------------	-------	----	-----	-----	-------

Not intended to convey or dispense water for human consumption through drinking or cooking

**Female Sprinkler Head Adapter - Brass Thread Insert Style with Long Body**  
Socket x FIPT

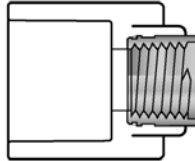

L4235-130	1X1/2	50	0	076	14.32
-----------	-------	----	---	-----	-------

Not intended to convey or dispense water for human consumption through drinking or cooking

**Male Adapter**  
MIPT x Socket

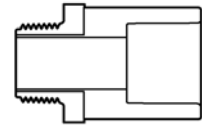

4236-007	3/4	40	160	076	20.87
4236-010	1	10	60	076	24.60
4236-012	1-1/4	10	60	076	27.11
4236-015	1-1/2	10	40	076	29.85
4236-020	2	8	32	076	40.95

**Female Sprinkler Head Adapter - Brass Thread Insert Style with Positioning Ring**  
Socket x FIPT

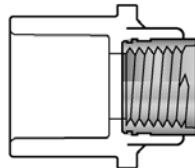

R4235-101	3/4X1/2	50	0	076	9.46
-----------	---------	----	---	-----	------

Not intended to convey or dispense water for human consumption through drinking or cooking

**Spigot Female Sprinkler Head Adapters - Brass Thread Insert Style**  
Spigot x FIPT

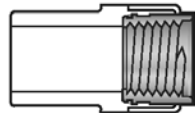

4238-101	3/4X1/2	50	0	076	9.46
4238-130	1X1/2	50	0	076	10.10

Not intended to convey or dispense water for human consumption through drinking or cooking

NOT FOR USE WITH COMPRESSED AIR OR GAS

# CPVC Orange Brass Grooved Coupling Adapter



Part Number	Size	Std Pk	Mstr Ctn	Disc Code	Price Each
-------------	------	--------	----------	-----------	------------

## Grooved Coupling Adapter Brass Groove End x Socket

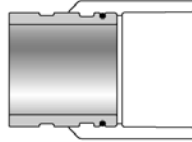

4233-012	1-1/4	10	40	076	97.98
4233-015	1-1/2	10	40	076	103.84
4233-020	2	8	32	076	120.27
4233-025	2-1/2	5	0	076	154.27
4233-030	3	5	0	076	171.50

Not intended to convey or dispense water for human consumption through drinking or cooking

NOT FOR USE WITH COMPRESSED AIR OR GAS

Made in the U.S.A.

Progressive Products from Spears® Innovation and Technology

Page 28



# CTS CPVC Tan Special Reinforced (SR) Fittings

Part Number	Size	Std Pk	Mstr Ctn	Disc Code	Price Each
-------------	------	--------	----------	-----------	------------

**SPECIAL REINFORCED 90° ELL**  
**Socket x SR Fipt - Stainless Steel**  
**Collar**

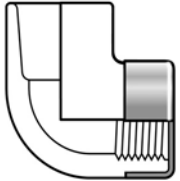

4107-005SR	1/2	50	300	035	5.19
------------	-----	----	-----	-----	------

**ZINC DROP EAR REINFORCED**  
**CTS 90° ELL (One Piece Unit)**  
**Socket x SR Fipt - Zinc Collar**



DEZ4107-005SR	1/2	10	150	035	11.67
---------------	-----	----	-----	-----	-------

**DROP EAR SPECIAL**  
**REINFORCED 90° ELL (Fitting**  
**Plus Bracket)**  
**Socket x SR Fipt - Stainless Steel**  
**Collar**

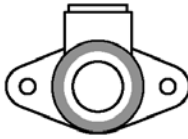

DE4107-005SR	1/2	10	200	035	33.52
--------------	-----	----	-----	-----	-------

**SPECIAL REINFORCED FEMALE**  
**ADAPTER**  
**Socket x SR Fipt - Stainless Steel**  
**Collar**

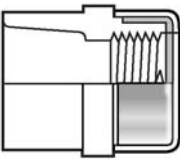

4135-005SR	1/2	25	200	035	4.01
4135-007SR	3/4	25	300	035	4.41
4135-010SR	1	5	100	035	9.22

**SPECIAL REINFORCED**  
**REDUCING FEMALE ADAPTER**  
**Socket x SR Fipt - Stainless Steel**  
**Collar**

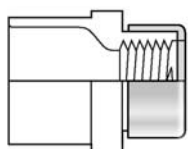

4135-131SR	1X3/4	25	150	035	8.80
------------	-------	----	-----	-----	------

Part Number	Size	Std Pk	Mstr Ctn	Disc Code	Price Each
-------------	------	--------	----------	-----------	------------

**REINFORCED MALE ADAPTER**  
**(Internal Stainless Steel**  
**Reinforced)**  
**R Mipt x Socket - Stainless Steel**  
**Sleeve**

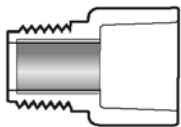

4136-005R	1/2	25	300	035	5.14
4136-007R	3/4	25	300	035	5.72
4136-010R	1	10	120	035	8.52

NOT FOR USE WITH COMPRESSED AIR OR GAS

Spears® Manufacturing Company

# CTS CPVC Tan Brass Thread Fittings



Part Number	Size	Std Pk	Mstr Ctn	Disc Code	Price Each
-------------	------	-----------	-------------	--------------	---------------

**GASKET SEALED BRASS  
THREAD TRANSITION FEMALE  
ADAPTER**

**Socket x Gasket FPT - Use NO Thread  
Sealant**

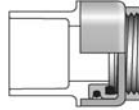

4135-005BRG	1/2	25	150	035	22.48
4135-007BRG	3/4	25	150	035	34.20
4135-010BRG	1	15	90	035	47.16
4135-012BRG	1-1/4	15	60	035	144.50
4135-015BRG	1-1/2	10	40	035	188.34
4135-020BRG	2	8	32	035	276.91

**GASKET SEALED BRASS  
THREAD TRANSITION  
REDUCING FEMALE ADAPTER**

**Socket x Gasket FPT - Use NO Thread  
Sealant**

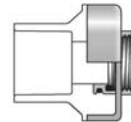

4135-101BRG	3/4X1/2	25	150	035	25.20
4135-130BRG	1X1/2	50	0	035	42.24

**TRANSITION MALE ADAPTER  
w/BRASS THREAD**

**Brass Mipt x Socket**

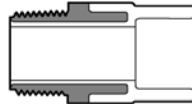

4136-005BR	1/2	60	360	035	18.12
4136-007BR	3/4	40	160	035	27.73
4136-010BR	1	10	60	035	38.06
4136-012BR	1-1/4	10	60	035	93.80
4136-015BR	1-1/2	10	40	035	123.84
4136-020BR	2	8	32	035	205.83

NOT FOR USE WITH COMPRESSED AIR OR GAS

Made in the U.S.A.

**Progressive Products from Spears® Innovation and Technology**

Page 30



# CTS CPVC Tan Gasket Sealed Thread Fittings

Part Number	Size	Std Pk	Mstr Ctn	Disc Code	Price Each
-------------	------	--------	----------	-----------	------------

**FEMALE ADAPTER with Gasket**  
**Socket x NPSC**

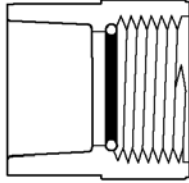

4135-005OR	1/2	25	200	035	2.71
4135-007OR	3/4	25	300	035	3.85
4135-010OR	1	5	100	035	4.39

NOT FOR USE WITH COMPRESSED AIR OR GAS



# Blue 75™ Thread Sealant



Part Number	Size	Std Pk	Mstr Ctn	Disc Code	Price Each
-------------	------	--------	----------	-----------	------------



## Blue 75™ Thread Sealant

SB75-005	1/4 Pint	24	0	895	9.94
SB75-010	1/2 Pint	24	0	895	15.83
SB75-020	Pint	12	0	895	25.59
SB75-030	Quart	12	0	895	45.99



# Special Reinforced (SR) & Metal Thread Transition Fittings & Adapters

## CONTENT

### CATALOG INFORMATION

TRANSITION FITTINGS OVERVIEW	1
APPROVALS	1
HOW TO USE THIS CATALOG	2
ORGANIZATION	2
PAGE & COLUMN HEADER INFORMATION	2
PRODUCT CONFIGURATION	2

### PVC White Special Reinforced (SR) Fittings

Special Reinforced Female Adapter Soc x SR Fipt - Stainless Steel Collar	3
Special Reinforced Tee Soc x SR Fipt - Stainless Steel Collar	3
Special Reinforced Reducing Tee Soc x SR Fipt - Stainless Steel Collar	3
Special Reinforced Reducing Tee Soc x SR Fipt-Stainless Steel Collar x Soc	3
Special Reinforced 90° Ell & Reducing 90° Ell Soc x SR Fipt - Stainless Steel Collar	3
Special Reinforced Coupling SR Fipt - Stainless Steel Collar	3
Special Reinforced Reducer Coupling SR Fipt - Stainless Steel Collar	4
Special Reinforced Spigot Female Adapter Spig x SR Fipt - Stainless Steel Collar	4
Special Reinforced Reducing Spigot Female Adapter Spig x SR Fipt - Stainless Steel Collar	4
Special Reinforced Reducing Female Adapter Soc x SR Fipt - Stainless Steel Collar	4
Special Reinforced Reducer Bushing Flush Style Spig x SR Fipt - Stainless Steel Collar	4
Special Reinforced Reducer Bushing Flush Style Mipt x SR Fipt - Stainless Steel Collar	4
Special Reinforced Cap SR Fipt - Stainless Steel Collar	4
Special Reinforced Union Soc x SR Fipt with Buna O-ring Seal - Stainless Steel Collar	5
Special Reinforced Union Soc x SR Fipt with EPDM O-ring Seal - Stainless Steel Collar	5

### PVC White Brass Thread Fittings

Transition Union Soc x Fipt with Brass Thread Insert & Buna-N O-ring Seal	6
Transition Union Soc x Fipt with Brass Thread Insert & EPDM O-ring Seal	6

### PVC Gray Special Reinforced (SR) Fittings

Special Reinforced Tee Soc x SR Fipt - Stainless Steel Collar	7
Special Reinforced Tee SR Fipt - Stainless Steel Collar	7
Special Reinforced Reducing Tee Soc x SR Fipt - Stainless Steel Collar	7
Special Reinforced Reducing Tee Soc x SR Fipt - Stainless Steel Collar x Soc	7
Special Reinforced 90° Ell Soc x SR Fipt - Stainless Steel Collar	7
Special Reinforced 90° Ell SR Fipt - Stainless Steel Collar	7
Special Reinforced Reducing 90° Ell Soc x SR Fipt - Stainless Steel Collar	8
Special Reinforced 45° Ell SR Fipt - Stainless Steel Collar	8
Special Reinforced Coupling SR Fipt - Stainless Steel Collar	8
Special Reinforced Reducer Coupling SR Fipt - Stainless Steel Collar	8
Special Reinforced Female Adapter Soc x SR Fipt - Stainless Steel Collar	8

# Special Reinforced (SR) & Metal Thread Transition Fittings & Adapters



## CONTENT

Encapsulated Special Reinforced Female Adapter Soc x ESR Fipt	8
Special Reinforced Spigot Female Adapter Spig x SR Fipt - Stainless Steel Collar	9
Encapsulated Special Reinforced Spigot Female Adapter Spig x ESR Fipt	9
Special Reinforced Reducing Female Adapter Soc x SR Fipt - Stainless Steel Collar	9
Special Reinforced Reducing Spigot Female Adapter Spig x SR Fipt - Stainless Steel Collar	9
Reinforced Male Adapter R Mipt x Soc - Stainless Steel Sleeve	9
Special Reinforced Reducer Bushing Mipt x SR Fipt - Stainless Steel Collar	9
Special Reinforced Reducer Bushing Flush Style Spig x SR Fipt - Stainless Steel Collar	9
Special Reinforced Cap SR Fipt - Stainless Steel Collar	10
Special Reinforced Union 2000 Soc x SR Fipt with EPDM O-ring Seal - Stainless Steel Collar	10
Special Reinforced Union 2000 Soc x SR Fipt with Viton® O-ring Seal - Stainless Steel Collar	10
Special Reinforced Union 2000 SR Fipt with EPDM O-ring Seal - Stainless Steel Collar	10
Special Reinforced Union 2000 SR Fipt with Viton® O-ring Seal - Stainless Steel Collar	10
Special Reinforced Union (Old Style) Soc x SR Fipt with EPDM O-ring Seal - Stainless Steel Collar	11
Special Reinforced Union (Old Style) Soc x SR Fipt with Viton® O-ring Seal - Stainless Steel Collar	11
Special Reinforced Flange One Piece Threaded SR Fipt - Stainless Steel Collar	11
PVC New Style Special Reinforced (SR) Threaded Tank Adapters with Neoprene Gaskets Soc x SR Fipt - Stainless Steel Collar	11
PVC New Style Special Reinforced (SR) Threaded Tank Adapters with EPDM Gaskets Soc x SR Fipt - Stainless Steel Collar	11
PVC New Style Special Reinforced (SR) Threaded Tank Adapters with Viton® Gaskets Soc x SR Fipt - Stainless Steel Collar	12
PVC New Style Special Reinforced (SR) Threaded Tank Adapters with Neoprene Gaskets Fipt x SR Fipt - Stainless Steel Collar	12
PVC New Style Special Reinforced (SR) Threaded Tank Adapters with EPDM Gaskets Fipt x SR Fipt - Stainless Steel Collar	12
PVC New Style Special Reinforced (SR) Threaded Tank Adapters with Viton® Gaskets Fipt x SR Fipt - Stainless Steel Collar	12
PVC Elastomer Expansion Joint with Neoprene Bellows SR Fipt - Stainless Steel Collar	13
PVC Elastomer Expansion Joint with EPDM Bellows SR Fipt - Stainless Steel Collar	13
<b>PVC Gray Brass Thread Fittings</b>	
Transition Tee Soc x Fipt With Brass Thread Insert	14
Transition Reducing Tee Soc x Fipt With Brass Thread Insert	14
Transition 90° Ell Soc x Fipt With Brass Thread Insert	14
Transition Reducing 90° Ell Soc x Fipt With Brass Thread Insert	14
Transition Female Adapter Soc x Fipt With Brass Thread Insert	14
Transition Female Adapter Spig x Fipt With Brass Thread Insert	14
Transition Reducing Female Adapter Soc x Fipt With Brass Thread Insert	14
Transition Female Adapter Soc x Fipt With 316 Stainless Steel Thread Insert	14



## Special Reinforced (SR) & Metal Thread Transition Fittings & Adapters

### CONTENT

Transiton Male Adapter w/ Brass Thread Brass Mipt x Socket	15
Union Soc x Fipt with Brass Thread Insert & Viton® O-ring Seal	15
Union Soc x Fipt with Brass Thread Insert & EPDM O-ring Seal	15
<b>CPVC Gray Special Reinforced (SR) Fittings</b>	
Special Reinforced Tee Soc x SR Fipt - Stainless Steel Collar	16
Special Reinforced Tee SR Fipt - Stainless Steel Collar	16
Special Reinforced Reducing Tee Soc x SR Fipt - Stainless Steel Collar	16
Special Reinforced Reducing Tee Soc x SR Fipt - Stainless Steel Collar x Soc	16
Special Reinforced 90° Ell Soc x SR Fipt - Stainless Steel Collar	16
Special Reinforced 90° Ell SR Fipt - Stainless Steel Collar	16
Special Reinforced Reducing 90° Ell Soc x SR Fipt - Stainless Steel Collar	17
Special Reinforced 45° Ell SR Fipt - Stainless Steel Collar	17
Special Reinforced Coupling SR Fipt - Stainless Steel Collar	17
Special Reinforced Reducer Coupling SR Fipt - Stainless Steel Collar	17
Special Reinforced Female Adapter Soc x SR Fipt - Stainless Steel Collar	17
Encapsulated Special Reinforced (SR) Female Adapter Soc x ESR Fipt	17
Special Reinforced Spigot Female Adapter Spig x SR Fipt - Stainless Steel Collar	17
Special Reinforced Reducing Female Adapter Soc x SR Fipt - Stainless Steel Collar	18
Encapsulated Special Reinforced (SR) Female Adapter Spig x ESR Fipt	18
Special Reinforced Reducing Spigot Female Adapter Spig x SR Fipt - Stainless Steel Collar	18
Reinforced Male Adapter R Mipt x Soc - Stainless Steel Sleeve	18
Special Reinforced Reducing Bushing Mipt x SR Fipt - Stainless Steel Collar	18
Special Reinforced Reducer Bushing Spig x SR Fipt - Stainless Steel Collar	18
Special Reinforced Cap SR Fipt - Stainless Steel Collar	18
Special Reinforced Union 2000 Soc x SR Fipt with EPDM O-ring Seal - Stainless Steel Collar	19
Special Reinforced Union 2000 Soc x SR Fipt with EPDM O-ring Seal - Stainless Steel Collar	19
Special Reinforced Union 2000 SR Fipt with Viton® O-ring Seal - Stainless Steel Collar	19
Special Reinforced Union 2000 SR Fipt with EPDM O-ring Seal - Stainless Steel Collar	19
Special Reinforced Union (Old Style) Soc x SR Fipt with EPDM O-ring Seal - Stainless Steel Collar	19
Special Reinforced Union (Old Style) Soc x SR Fipt with Viton® O-ring Seal - Stainless Steel Collar	19
Special Reinforced Flange One Piece Threaded SR Fipt - Stainless Steel Collar	20
CPVC New Style Special Reinforced (SR) Threaded Tank Adapters with Neoprene Gaskets Soc x SR Fipt - Stainless Steel Collar	20
CPVC New Style Special Reinforced (SR) Threaded Tank Adapters with EPDM Gaskets Soc x SR Fipt - Stainless Steel Collar	20
CPVC New Style Special Reinforced (SR) Threaded Tank Adapters with Viton® Gaskets Soc x SR Fipt - Stainless Steel Collar	20
CPVC New Style Special Reinforced (SR) Threaded Tank Adapters with Neoprene Gaskets Fipt x SR Fipt - Stainless Steel Collar	20

# Special Reinforced (SR) & Metal Thread Transition Fittings & Adapters



## CONTENT

CPVC New Style Special Reinforced (SR) Threaded Tank Adapters with EPDM Gaskets Fipt x SR Fipt - Stainless Steel Collar	21
CPVC New Style Special Reinforced (SR) Threaded Tank Adapters with Viton® Gaskets Fipt x SR Fipt - Stainless Steel Collar	21
CPVC Elastomer Expansion Joint with EPDM Bellows SR Fipt - Stainless Steel Collar	21

### **CPVC Gray Brass Thread Fittings**

Transition Tee Soc x Fipt With Brass Thread Insert	22
Transition Reducing Tee Soc x Fipt With Brass Thread Insert	22
Transition 90° Ell Soc x Fipt With Brass Thread Insert	22
Transition Reducing 90° Ell Soc x Fipt With Brass Thread Insert	22
Transition Female Adapter Soc x Fipt With Brass Thread Insert	22
Transition Female Adapter Soc x Fipt With Type 316 Stainless Steel Thread Insert	22
Transition Male Adapter w/Brass Thread Brass Mipt x Socket	22
Union Soc x Fipt with Brass Thread Insert & Viton® O-ring Seal	22
Union Soc x Fipt with Brass Thread Insert & EPDM O-ring Seal	23

### **CPVC Orange Special Reinforced (SR) Fittings**

Sprinkler Head Tee - Special Reinforced Plastic Thread Style with Wrench Flats Socket x Socket x SR FIPT - Zinc Collar	24
Sprinkler Head Tee - Special Reinforced Plastic Thread Style Socket x Socket x SR FIPT - Stainless Steel Collar	24
Sprinkler Head Tee - Special Reinforced Plastic Thread Style Socket x SR FIPT x Socket - Stainless Steel Collar	24
Sprinkler Head 90° Ell - Special Reinforced Plastic Thread Style Socket x SR FIPT - Stainless Steel Collar	24
Female Adapter - Special Reinforced Plastic Thread Style Socket x SR FIPT - Stainless Steel Collar	24
Female Sprinkler Head Adapter - Special Reinforced Plastic Thread Style Socket x SR FIPT - Stainless Steel Collar	24
Female Sprinkler Head Adapter - Special Reinforced Plastic Thread Style with Socket Body Wrench Flats Socket x SR FIPT - Stainless Steel Collar	24
Female Sprinkler Head Adapter - Special Reinforced Plastic Thread with Metal Thread Start Socket x SR FIPT - Zinc Collar	25
Female Sprinkler Head Adapter - Special Reinforced Plastic Thread Style with Positioning Ring Socket x SR FIPT - Stainless Steel Collar	25
Spigot Female Sprinkler Head Adapters - Special Reinforced Plastic Threaded Style Spigot x SR FIPT - Stainless Steel Collar	25
Adjustable Sprinkler Head Adapters - Special Reinforced Plastic Thread Style Socket x SR FIPT - Zinc Collar	25
Adjustable Sprinkler Head Adapters - Special Reinforced Plastic Thread Style Spigot x SR FIPT - Zinc Collar	25



# Special Reinforced (SR) & Metal Thread Transition Fittings & Adapters

## CONTENT

Spigot Female Adapter - Special Reinforced Plastic Thread Style Spigot x SR FIPT - Stainless Steel Collar 25

### CPVC Orange Brass Thread Fittings

Sprinkler Head Tee - Brass Thread Insert Style Socket x Socket x FIPT	26
Sprinkler Head Tee - Brass Thread Insert Style Socket x FIPT x Socket	26
Sprinkler Head 90° Ell - Brass Thread Insert Style Socket x FIPT	26
Female Adapter - Brass Thread Insert Style Socket x FIPT	26
Spigot Female Adapter - Brass Thread Insert Style Spigot x FIPT	26
TorqueSafe™ Female Sprinkler Head Adapter - Gasket Sealed Brass Thread Insert Style Socket x Gasket FIPT	26
Female Sprinkler Head Adapter - Brass Thread Insert Style Socket x FIPT	27
Female Sprinkler Head Adapter - Brass Thread Insert Style with Long Body Socket x FIPT	27
Female Sprinkler Head Adapter - Brass Thread Insert Style with Positioning Ring Socket x FIPT	27
Spigot Female Sprinkler Head Adapters - Brass Thread Insert Style Spigot x FIPT	27
Bushing - with Brass Thread Insert Spigot x FIPT	27
Male Adapter MIPT x Socket	27

### CPVC Orange Brass Grooved Coupling Adapter

Grooved Coupling Adapter Brass Groove End x Socket 28

### CTS CPVC Tan Special Reinforced (SR) Fittings

SPECIAL REINFORCED 90° ELL Socket x SR Fipt - Stainless Steel Collar	29
ZINC DROP EAR REINFORCED CTS 90° ELL (One Piece Unit) Socket x SR Fipt - Zinc Collar	29
DROP EAR SPECIAL REINFORCED 90° ELL (Fitting Plus Bracket) Socket x SR Fipt - Stainless Steel Collar	29
SPECIAL REINFORCED FEMALE ADAPTER Socket x SR Fipt - Stainless Steel Collar	29
SPECIAL REINFORCED REDUCING FEMALE ADAPTER Socket x SR Fipt - Stainless Steel Collar	29
REINFORCED MALE ADAPTER (Internal Stainless Steel Reinforced) R Mipt x Socket - Stainless Steel Sleeve	29

### CTS CPVC Tan Brass Thread Fittings

GASKET SEALED BRASS THREAD TRANSITION FEMALE ADAPTER Socket x Gasket FPT - Use NO Thread Sealant	30
GASKET SEALED BRASS THREAD TRANSITION REDUCING FEMALE ADAPTER Socket x Gasket FPT - Use NO Thread Sealant	30
TRANSITION MALE ADAPTER w/BRASS THREAD Brass Mipt x Socket	30

### CTS CPVC Tan Gasket Sealed Thread Fittings

FEMALE ADAPTER with Gasket Socket x NPSC 31

### Blue 75™ Thread Sealant

Blue 75™ Thread Sealant 32

# NOTES

## The Spears® Quality Policy

It is the policy and objective of Spears® Manufacturing Company to produce a superior quality product suitable for its intended use, with regard to functionality, structural integrity, and conformance to established industry standards and practices. It is the commitment of this Company to do so in a manner which provides consistency of product quality, optimum availability, and superior customer service, while maintaining efficiency of operations and profitability necessary to perpetuate product improvement and customer satisfaction. Furthermore, it is recognized that the attainment of these objectives is the responsibility of all Company operations and personnel according to their respective functions.



### SPEARS® MANUFACTURING COMPANY • CORPORATE OFFICE

15853 Olden St., Sylmar, CA 91342 • PO Box 9203, Sylmar, CA 91392  
(818) 364-1611 • [www.spearsmfg.com](http://www.spearsmfg.com)



#### PACIFIC SOUTHWEST

15860 Olden St.  
Sylmar (Los Angeles), CA 91342  
(818) 364-1611 • (800) 862-1499  
Fax (818) 367-3014

#### ROCKY MOUNTAIN

4880 Florence St.  
Denver, CO 80238  
(303) 371-9430 • (800) 777-4154  
Fax (303) 375-9546

#### UTAH

5395 West 1520 South  
Salt Lake City, UT 84104  
(303) 371-9430 • (800) 777-4154  
Fax (303) 375-9546

#### SOUTHEAST

4205 Newpoint Pl., Suite 100  
Lawrenceville (Atlanta), GA 30043  
(678) 985-1263 • (800) 662-6326  
Fax (678) 985-5642

#### MIDWEST

1 Gateway Ct., Suite A  
Bolingbrook (Chicago), IL 60440  
(630) 759-7529 • (800) 662-6330  
Fax (630) 759-7515

#### NORTHWEST

4103 C St. NE Suite 200  
Auburn (Seattle), WA 98002  
(253) 939-4433 • (800) 347-7327  
Fax (253) 939-7557

#### SOUTH CENTRAL

1000 Lakeside Parkway  
Flower Mound, TX 75028  
(469) 528-3000 • (800) 441-1437  
Fax (469) 528-3001

#### NORTHEAST

590 Industrial Dr., Suite 100  
Lewisberry (Harrisburg), PA 17339-9532  
(717) 938-8844 • (800) 233-0275  
Fax (717) 938-6547

#### FLORIDA

9563 Parksouth Court  
Orlando, FL 32837  
(407) 843-1960 • (800) 327-6390  
Fax (407) 425-3563

#### INTERNATIONAL SALES

15853 Olden St.  
Sylmar (Los Angeles), CA 91342  
(818) 364-1611 • Fax (818) 898-3774