



LabWaste™

CPVC Corrosive Waste
Drainage Systems



TECHNICAL INFORMATION & INSTALLATION GUIDE

August 1, 2012

SUPERSEDES ALL PREVIOUS EDITIONS

U.S. Patent No. 7,178,557
Manufactured to ASTM F 2618
NSF® cw Certified For
Corrosive Waste



Visit our web site
www.spearsmfg.com

LW-4-0812





LabWaste™ CPVC Technical Information & Installation Guide

Additional LabWaste™ Publications

Spears® **LabWaste™** CPVC Corrosive Waste Drainage Systems & Standard CPVC & HDPE Neutralization Tanks – Price Schedule & Technical Information Catalog SSB-1
Spears® **LabWaste™** CPVC Corrosive Waste Drainage Systems – General Data Sheet LW-2

This manual provides basic technical information, dimensions and installation guidelines for Spears® **LabWaste™** CPVC Corrosive Waste Drainage Systems that are designed for commercial, industrial, and institutional drainage system applications. This unique product developed by Spears® has been awarded a U.S. Patent, No. 7,178,557 and is manufactured to ASTM F 2618 *Standard Specification for Chlorinated Poly (Vinyl Chloride) (CPVC) Pipe and Fittings for Chemical Waste Drainage Systems* developed for this system. Spears® **LabWaste™** CPVC Corrosive Waste Drainage Systems carries a limited Lifetime Warranty. Please refer to the above publications or contact Spears® Technical Services for additional information not covered.

Laboratory Applications

Its broad range of resistance to chemical and corrosive wastes make Spears® **LabWaste™** CPVC systems very well suited for commercial, institutional and academic laboratory drainage installations. These applications are best characterized as the routine disposal of a wide variety of hot and cold chemicals in relatively small quantities accompanied by water for the purpose of dilution and flushing. Due to the interactions potentially encountered in multi-chemical laboratory drainage disposal, Spears® recommends routine flushing of the system with water during disposal as a part of prudent laboratory practices. A properly designed and installed **LabWaste™** CPVC system provides total dilution and disposal need for years of dependable service.

Industrial & Commercial Special Waste Applications

Spears® **LabWaste™** CPVC products can be used in a very broad variety of dedicated waste applications with proper evaluation of waste medium and service conditions. **DO NOT** follow Chemical Resistance Tables recommendations in this manual for these applications. For non-laboratory applications, refer to CPVC pressure system resistance data for appropriate chemical resistance guidelines. Please contact Spears® Technical Services for additional information.

Chemical Resistance Overview

Spears® **LabWaste™** CPVC systems are inert to most mineral acids, bases, salts and aliphatic hydrocarbons, and compares favorably to other non-metals in these chemical environments.

General Chemical Resistance Overview:

Weak Acids	Excellent	Salts	Excellent
Strong Acids	Excellent	Aliphatic Solutions	Good
Weak Bases	Excellent	Halogens	Good-Fair
Strong Bases	Excellent	Strong Oxidants	Good-Fair

Refer to *Chemical Resistance Information* section at the end of this manual for Chemical Resistance Tables and additional information and detail.

Applicable Conformance Standards & Certifications

Spears® **LabWaste™** CPVC Corrosive Waste Drainage System is a complete system of pipe, fittings and solvent cement independently (3rd party) tested, evaluated and certified by the following laboratories and agencies. Each of these approvals is routinely monitored through an ongoing program of periodic inspection and testing by the certifying agency.

- **ASTM F 2618** - Certified for corrosive waste end use by NSF International (NSF® cw) in accordance with ASTM F 2618, *Standard Specification for Chlorinated Poly (Vinyl Chloride) (CPVC) Pipe and Fittings for Chemical Waste Drainage Systems*.
- **NSF ORD 1022** - Certified as an Other Recognized Document (ORD) that defines the product specific requirements for Chlorinated Poly Vinyl Chloride (CPVC) Chemical Waste Systems in accordance with the requirements of ASTM F 2618 for use in Canada.
- **Uniform Plumbing Code** - Certified for use in accordance with the Uniform Plumbing Code (UPC) by NSF International as specified in IAPMO IGC 210, *Interim Guide Criteria for Chlorinated Poly (Vinyl Chloride) (CPVC) Pipe and Fittings for Limited Chemical Waste Drainage System*. (NSF®-U.P.Code).
- **International Plumbing Code** - Approved for use in accordance with the International Plumbing Code (IPC) by the International Codes Council Evaluation Services (ICC - ES) in accordance with ICC - ES PMG Listing PMG - 1018 for Spears® **LabWaste™** CPVC Corrosive Waste Drainage System (See ICC - ES PMG Listing PMG - 1018 at www.icc-es-pmg.org.)
- **American Bureau of Shipping (ABS) Type Approval** - Spears® **LabWaste™** CPVC Corrosive Waste Drainage System pipe and fittings are ABS Type Approved for marine and offshore applications in nominal pipe sizes through 12". Type Approval details and restrictions are specified in ABS Certificate # 10-HS539421-1-PDA available on the ABS website at www.eagle.org.

LabWaste™ CPVC Technical Information & Installation Guide



Typical Physical Properties of Spears® LabWaste™ CPVC Material

Property	Test Method	Typical Value
Mechanical Properties @ 73°F		
Specific Gravity	ASTM D 792	1.49
Tensile Strength, psi	ASTM D 638	9000
Tensile Modulus, psi	ASTM D 638	420,000
Flexural Strength	ASTM D 790	12,000
Izod Impact (notched @73°F)	ASTM D 256	
Fittings		3.0
Pipe		5.5
Thermal Properties		
Heat Deflection Temperature 264 psi	ASTM D 648	
Fitting		214°F
Pipe		230°F
Thermal Conductivity, BTU/hr/sq ft/°F/in	ASTM C 177	.95
Coefficient of Linear Expansion, in/in/°F	ASTM D 696	3.2 x 10 ⁻⁵
Flammability		
Limiting Oxygen Index	ASTM D 2863	60
UL 94 Rating	UL 94	V-0, 5VB
Flame & Smoke Rating¹		
Flame Spread	CAN/ULC S 102.2	<25
Smoke Developed	UL 723/ASTM E 84	<50
Solvent Cement	ASTM F 2618/ASTM F 493	Heavy Body; Mustard Yellow Color

Typical Physical Properties data is based on information from material suppliers. It is provided as a guideline for service and is not to be considered a warranty of performance.

1- Based on test of physical product, including solvent cement welded pipe and fittings assemblies, as opposed to test of material only.

Fire Resistance

Material used in Spears® **LabWaste™** CPVC systems has a UL 94 flammability rating of V-0, 5VB. Pipe and fittings have been Listed and rated based on *finished product* tests, as opposed to a material test only, for surface burning characteristics of flame spread and smoke density developed by Underwriters Laboratories of Canada under standard test method CAN/ULC S102.2-M88. Additional test of **LabWaste™** pipe with dry fit caps was conducted by Southwest Research Institute (SwRI) Department of Fire Technology under UL 723/ASTM E 84 (modified to test finished product). Pipe and fitting components ratings are below the 25 maximum flame spread and 50 maximum smoke density developed typically required for exposed air plenum installation. Check local codes for acceptability. Use of approved plenum wrap or transition connectors to other material may be used if required.

Pipe & Fittings

Spears® **LabWaste™** CPVC pipe and fittings are produced to the dimensional and performance requirements of ASTM F 2618, *Standard Specification for Chlorinated Poly (Vinyl Chloride) (CPVC) Pipe and Fittings for Chemical Waste Drainage Systems*. **LabWaste™** CPVC fitting configurations are produced to applicable DWV patterns of ASTM D 3311, *Standard Specification for Drain, Waste, and Vent (DWV) Plastic Fittings Patterns*, plus various specialty patterns and manufactured specified configurations not included in D 3311. All drainage fittings with 90° angles (sanitary tees, elbows, etc.) have socket pitch to maintain approximately 1/4" per foot drainage. **LabWaste™** CPVC pipe is produced to dimensions specified in ASTM F 2618 with sizes greater than 12" produced to Schedule 40 dimensions of ASTM F 441, *Standard Specification for Chlorinated Poly (Vinyl Chloride) (CPVC) Plastic Pipe, Schedule 40 and 80*.

Schedule 40 CPVC Pipe Dimensions (inch)

Pipe Diameter	1-1/2	2	3	4	6	8	10	12	14	16	18	20	24
Avg. O.D.	1.900	2.375	3.500	4.500	6.625	8.625	10.750	12.750	14.000	16.000	18.000	20.000	24.000
Avg. I.D.	1.592	2.049	3.042	3.998	6.031	7.943	9.976	11.889	13.073	14.940	16.809	18.743	22.544
Min. Wall	.145	.154	.216	.237	.280	.322	.365	.406	.437	.500	.562	.593	.687



LabWaste™ CPVC Technical Information & Installation Guide

Expansion & Contraction

Spears® **LabWaste**™ CPVC products, like all piping materials, expand and contract with changes in temperature. If the coefficient of linear expansion is 3.2×10^{-5} in./in. °F, a 25°F change in temperature will cause an expansion of 1 inch for a 100-foot straight length. For most operating and installation conditions, expansion and contraction can be accommodated at changes of direction, or simple expansion loops can be used. For underground installations, snaking the pipe in the trench can be used where necessary to accommodate expansion and contraction.

Thermal expansion change in length is calculated from Length of Run in feet, expected Change in Temperature and given Coefficient of Linear Thermal Expansion of 3.2×10^{-5} in./in. °F for CPVC:

$$\Delta L = 12eL (\Delta T)$$

Where:

$$e = 3.2 \times 10^{-5} \text{ in./in. } ^\circ\text{F}$$

L = Length of Run in feet

ΔT = Temperature Change in °F

Example:

How much will a 50 ft. run Spears® **LabWaste**™ pipe expand if the expected ambient temperature will range from 45°F to 85°F?

$$\Delta L = 12eL (\Delta T)$$

$$\Delta L = 12 \times .000032 \times 50 \times 40$$

$$\Delta L = .768 \text{ inches}$$

The following table provides quick reference in identifying expansion length change for different run lengths of pipe at various anticipated temperature changes.

Thermal Expansion Table

Length of Run (L) in feet	Length Change in Inches (ΔL) for Specified Change in Temperature (ΔT)								
	20°F	30°F	40°F	50°F	60°F	70°F	80°F	90°F	100°F
10	.08	.12	.15	.19	.23	.27	.31	.35	.38
20	.15	.23	.31	.38	.46	.54	.61	.69	.77
40	.31	.46	.61	.77	.92	1.08	1.23	1.38	1.54
50	.38	.58	.77	.96	1.15	1.34	1.54	1.73	1.92
70	.54	.81	1.08	1.34	1.61	1.88	2.15	2.42	2.69
90	.69	1.04	1.38	1.73	2.07	2.42	2.76	3.11	3.46
120	.92	1.38	1.84	2.30	2.76	3.23	3.69	4.15	4.61

Joining Methods

Spears® **LabWaste**™ CPVC pipe and fittings are easily joined using Spears® LW-5 One-Step Solvent Cement that has been specially formulated for corrosive/acid waste applications and manufactured in accordance with ASTM F 493, *Standard Specification for Solvent Cements for Chlorinated Poly (Vinyl Chloride) (CPVC) Plastic Pipe and Fittings*, as specified in ASTM F 2618. When cured, this cement provides a fused joint that maintains the same physical and chemical resistance properties as the CPVC components in the system. Spears® LW-5 is a “one-step” cement and does not require the use of primer. Spears® **LabWaste**™ CPVC systems may be additionally joined using threaded (NPT) or flanged connections where removal or connection to supplementary equipment is required. Special transition couplings are available for joining to Polypropylene, PVDF, glass or Duriron systems.

Solvent Cement Joints – Store below 90°F (33°C). Stir and use as is. If jelled, replace. Use within 2 years of date stamped on can. This cement is designed for use without a Primer. Check local code requirements before using Spears® LW - 5 cement.

1. Cut pipe square, deburr and chamfer (bevel 10° to 15°). Clean and dry joining surfaces.
2. Check dry fit. For interference fit, pipe should push 1/4 to 3/4 way into fitting snugly.
3. Use a suitable applicator at least 1/2 size of pipe diameter; for larger sizes use brush or roller.
4. Apply a full even layer of cement on the pipe equal to the socket depth. Coat the fitting socket with a medium layer. Avoid excess and puddling. If necessary, apply a second full layer on pipe.
5. Assemble while cement is wet. If not wet, recoat all parts before assembly. Assure pipe bottoms into fitting socket using a 1/8 to 1/4 turns twist. To avoid push out and allow for initial set, hold for about 30 seconds. Wipe off excess. Handle newly assembled joints carefully.

LabWaste™ CPVC Technical Information & Installation Guide



An Initial Set time is recommended to provide good handling strength after which the joint will handle normal stresses of installation. Cure Time is the recommended waiting period prior to placing the joint into service and before any pressure testing of the system. Set and cure times are relative to temperature at time of installation. Best results are obtained at temperatures between 40° and 110°F. Due to the many field variables, these should be used as a general guide only.

Recommended Set & Cure Times

Temperature	Initial Set	Cure
60°F - 100°F	30 min.	1 hr.
40°F - 60°F	1 hr.	2 hrs.
0°F	2 hrs.	4 hrs.

In moist or humid conditions (relative humidity above 60%) allow 50% more cure time.

Average Number of Joints per Quart of LW-5 One-step Cement

Pipe Diameter	1-1/2	2	3	4	6	8	10	12	14	16
No. of Joints	90	60	40	30	10	5	2-3	1-2	3/4	1/2-3/4

Estimate based on laboratory tests. Due to many field variables, these figures should be used as a general guide only.

Threaded Joints - Spears® Manufacturing Company highly recommends the use of Spears® **BLUE 75™** thread sealant, which has been tested for compatibility with Spears® products. Please follow the sealant Manufacturer's Application/Installation instructions. Choice of another appropriate thread sealant is at the discretion of the installer.

WARNING: Some pipe joint compounds or pastes may contain substances that could cause stress cracks in CPVC. For transitions to metal threaded systems, all cutting oils must be removed and the metal pipe thoroughly flushed and degreased prior to assembly with CPVC systems.

1. Apply joint sealant to the male pipe threads ONLY.
2. Thread joint hand tight for initial assembly.
3. Using commercial strap wrenches tighten 1 to 2 turns beyond hand tight; avoid over tightening. **DO NOT** use conventional pipe wrenches that can damage plastic fittings.



If a tape sealant is used:

1. Use TFE tape no less than 25 mil thick.
2. Initial wrap must fully cover the thread end.
3. Wrap clockwise with standard pipe threads.
4. Use only 2-3 wraps of tape.

DO NOT use combination of paste and tape sealants.

Flanged Connections - Solvent cement flange hub to pipe according to preceding instructions. Use full faced, 1/8" thick gaskets of a material suitable for the intended application having a Shore "A" durometer of approximately 60. Use of well lubricated bolts and flat washers is required. Bolts must be tightened in a 180° opposing pattern to the recommended torque values.

Flange Size (in.)	Bolt Torque (ft.-lb.)	Torque Sequence
1-1/2	12	
2-4	25	
6-8	40	
10	64	
12	95	
14-16	110	

LabWaste™ Transitions To Other Systems – Spears® **LabWaste™** Corrosive Waste Drainage System provides a complete line of transition fittings for use with other corrosive waste piping materials for system additions and retrofits.

P099 Transition Coupling: Hub X Compression. Allows connection of **LabWaste™** to Polypropylene or PVDF pipe and solvent cement socket connection to CPVC system. A safety groove must be cut into the Polypropylene or PVDF pipe to resist pull out. A groove cutting tool is available from Spears®

P093 Elastomer Transitions Coupling For Glass: IPS Clamp Joint X Glass Clamp Joint. Allows mechanical connection of **LabWaste™** CPVC pipe to plain end Kimax® glass pipe. Consists of high performance fluoroelastomer (FKM) sleeve, an outer stainless steel shear ring and two AISI 301 stainless steel clamping bands.

Made in the U.S.A.



LabWaste™ CPVC Technical Information & Installation Guide

P098 Glass Transition Coupling: Spigot X Bead Clamp. Allows mechanical connection of **LabWaste™** to beaded-end glass drainage pipe. Coupling consists of a CPVC beaded-end matching glass pipe bead and CPVC pipe diameter spigot end for solvent cement connection. This requires a glass system's mechanical connector, available from Schott Scientific Glass, part# 6650-XXXX Bead-to-Bead end.

P094 Elastomer Transitions Coupling For Duriron®: IPS Clamp Joint X Duriron® Clamp Joint. Allows mechanical connection of **LabWaste™** CPVC pipe to plain end Duriron® pipe. Consists of high performance fluoroelastomer (FKM) sleeve, an outer stainless steel shear ring and two AISI 301 stainless steel clamping bands.

P095 Duriron® Mechanical Transition Fitting: Mechanical Joint X CPVC Pipe Size. Allows mechanical connection of **LabWaste™** to Duriron (siliconized iron) pipe. Fitting consists of Duriron pipe diameter spigot (male pipe end) and CPVC pipe diameter spigot end for solvent cement connection. Requires use of Duriron Mechanical Joint Coupling that consists of an inner sleeve of PTFE surrounded by an outer sleeve of Neoprene rubber held in place by a stainless steel coupling. Duriron® Mechanical Joint Coupling available through Flowserve.

P097 Duriron® Caulk Transition Coupling: Spigot x Caulk Joint. Allows caulk-joint connection of **LabWaste™** pipe to Duriron borosilicate systems. Coupling consists of Duriron pipe diameter male end for mating to Duriron belled pipe end and CPVC pipe diameter spigot end for solvent cement connection. This requires use of special chemical acid-resistant oakum packing available from Flowserve (Red Stripe Sealite A312 Rope) and plastic lead/caulk purchased from others. **DO NOT** use hot lead or oiled Oakum for this type of caulk-joint.

P096 Grooved Coupling Adapter: Groove X Socket. Allows connection of the **LabWaste™** to grooved metal piping systems. Requires use of a Metal Grooved Coupling with gasket. A flexible style grooved coupling must be used for plastic only. **Do not use rigid style couplings.** Use either Victaulic Flexible Grooved Couplings Part# 75 & 77 or Gruvlok Flexible Grooved Couplings Part# 7001 & 7000.

Please contact Spears® for special construction of any system transition connection needs not specified.

Support Spacing

Spears® **LabWaste™** CPVC systems should be properly supported to avoid stress caused by sagging and system component loads. Support should be given to concentrated system loads, such as flanges and where changes in direction occur. Such support should be made as close to fittings as possible, yet allow for movement due to expansion and contraction.

Conventional pipe hangers and brackets can be used. However, hangers must **NOT** be used to pull the piping system into position or over tightened to either restrict necessary movement or cut into pipe. Hangers should be smooth, free of burrs and provide as much load-bearing surface as possible.

Systems should be supported in accordance with applicable plumbing codes. Check local codes for additional requirements. The following chart shows recommended horizontal support spacing for un-insulated continuous spans with no concentrated loads. This information is provided as a general guideline. Local codes, engineering specifications, and system installation conditions may require significant variations.

Recommended Hanger Spacing (feet)

Pipe Diameter	1-1/2	2	3	4	6	8	10	12	14	16
Hanger Spacing	6	6	7	7-1/2	8	9	10	10-1/2	11	12

Underground Installation

Spears® **LabWaste™** CPVC systems may be installed underground in a smooth, uniform trench bottom that supports the pipe over its entire length, free of rocks and debris. Subsoil should be stable to provide physical protection for the pipe and fittings. Where large boulders are not removed, trench should be padded with sand or fine-grained soil. Trench should be wide enough to provide room for joining pipe in the trench and to allow snaking from side-to-side to provide slack for future expansion-contraction. Install a larger size pipe as a sleeve where piping must pass through masonry walls. Use only solvent cement connection in underground piping. System should be tested in accordance with local plumbing codes prior to back filling. Pipe should be surrounded with an initial backfill material having a particle size of 1/2" or less, free of sharp rock or debris and uniformly compacted in layers. Refer to ASTM D 2321, *Underground Installation of Thermoplastic Pipe for Sewer and Other Gravity-Flow Applications*, for additional information on underground installations.

Acid Neutralization/Dilution Tanks for Use With **LabWaste™** CPVC Systems

Neutralization or dilution tanks are required by codes for the purpose of neutralizing corrosive wastes. Corrosive liquids, spent acids or other harmful chemicals that destroy or injure a drain, sewer, soil or waste pipe, or create noxious or toxic fumes or interfere with sewage treatment processes are prohibited from discharge into the plumbing system without being neutralized or treated. A variety of system designs and treatment methods can be used for neutralization and dilution. For proper performance, Spears® recommends use of professional assistance in analysis of the application, neutralization system design, equipment selection, and specific maintenance requirements.

Spears® offers a standard selection of HDPE in 5 gallon to 3000 gallon capacities and CPVC tanks in 5 gallon to 55 gallon capacities with a variety of connection and vent options, plus convenient 1-gallon Dilution Tank designed for under-sink installation. Tanks can also be custom produced in virtually any size, shape, or connection configuration, including custom double-containment tanks. Contact Spears® Technical Services with desired specifications for custom quotation. See Price Schedule SSB-1 List Price Catalog Section, "Spears® **LabWaste™** Standard CPVC & HDPE Neutralization Tanks", for pricing, additional information, selection detail and available options such as venting, tank extensions, manhole ports, pedestrian and traffic covers.

LabWaste™ CPVC Technical Information & Installation Guide



Installation Considerations - Except for under-sink installations, tank should be located on the lowest floor or basement room. It is recommended that the tank be in a concrete vault on a smooth flat surface. Where necessary, tanks may be installed on sturdy sheeting or directly into the ground. In all cases, the surface must be capable of uniformly supporting the tank weight, including effluent and neutralization medium.

Neutralization tanks and tank extensions are not warranted for direct burial applications. Tanks must be properly placed and secured with no applied stresses, within a dry concrete vault. However, if direct burial is used without warranty, custom centerlines must be furnished from top of cover down to fitting centerline instead of specified tank bottom to fittings centerline since tank heights can vary. The top of the tank must remain accessible for servicing and clean out either directly or by manhole cover. Tanks may be installed under foot or light vehicle traffic with use of appropriate covers and support. Tanks themselves are not to be used to support traffic loading.

Avoid strain when installing the pipe to tank fitting connections. Tanks must **NOT** be supported by the inlet, outlet, or vent piping.

The following recommendation from the American Society of Plumbing Engineers (ASPE) may be used as a guideline for sizing tanks according to the number of lab sinks.

Neutralization Tank Sizing Table

Number of Lab Sinks	Tank Size		Number of Lab Sinks	Tank Size	
	Gallons	Liters		Gallons	Liters
2	5	18.9	60	200	757
4	15	56.8	75	275	1040.9
8	30	113.6	110	360	1362.6
16	55	208.2	150	500	1898.5
22	75	283.9	175	550	2081.8
27	90	340.7	200	650	2460.3
30	108	408.8	300	1200	4542
40	150	567.8	500	2000	7570
50	175	662.4	600	3000	11355

Limestone Chips for Acid Neutralization Tanks - Most state and local codes require the addition of a neutralization medium in acid waste tanks with the addition of water for dilution prior to discharge into a sanitary sewer system. Limestone must be 1" to 3" in diameter with a calcium carbonate content of at least 90%. Spears® offers high grade Limestone Chips having a calcium carbonate content of approximately 95%. The use of Limestone Chips is generally one of the best and least expensive means of acid neutralization, but may be used in conjunction with more sophisticated chemical treatments if necessary.

How Much Limestone to Use - The following is a guideline for pounds of Limestone Chips to use for one (1) tank filling (charge). It is recommended that sufficient quantity be ordered for more than one filling.

Tank Size Gallons	Approx. Pounds	Tank Size Gallons	Approx. Pounds
5	50	300	3,200
15	100	350	4,000
30	200	500	5,000
55	500	550	7,500
100	1,000	650	9,000
150	1,750	1200	11,000
175	1,900	2000	16,000
200	2,500	3000	25,000
275	3,200		

General Tank Maintenance Guidelines - Tanks should be inspected routinely for accumulation of precipitated sludge and debris that must be cleaned out (usually scooped out) and for periodic addition of limestone and water if necessary. While once every one to three months may be sufficient, professional assistance should be sought to establish a proper schedule based on actual use. **Note:** Tank must be filled with water prior to carefully adding Limestone Chips to charge the system. Request instruction sheet.



LabWaste™ CPVC Technical Information & Installation Guide

System Pressure Testing

Spears® **LabWaste**™ CPVC systems should be tested with water as follows, or according to local plumbing codes. Test only after sufficient joint cure (see “Recommended Set & Cure Time”). The system may be tested in its entirety or isolated at each floor or in sections for testing.

Close all openings tight except the highest opening and fill the system to the point of overflow. Fill the system slowly, being sure to allow all air to escape. A minimum of ten (10) foot (3048 mm) head should be used for entire system or section tested. Allow the system/section under test to set 15 minutes before inspection for leaks.

Drain each section after inspection. Any leaking solvent cement joints should be cut from the system, replaced and retested after proper joint cure. Check any leaking mechanical joints for proper installation, applicable tightening, and presence of any debris in the joint. Reassemble and retest.

Supplemental Equipment Not Specified in this Manual

A variety of supplemental equipment including, pump stations, laboratory workstations, and fume hoods are built to customer specifications. Standard Laboratory fixtures, floor drains, wall drains and traps plus manual or actuated valves are also available. Spears® can custom fabricate virtually any **LabWaste**™ system component. Contact Spears® for additional needs or a custom quotation.

System Integrity

Spears® **LabWaste**™ products have been developed and designed to be used as a total system consisting of pipe, fittings, accessories, solvent cement and thread sealant. All-Spears® **LabWaste**™ components should be used in order to insure a sound piping system. Substitution of other products for Spears® **LabWaste**™ pipe, fittings, or solvent cement may be detrimental to system integrity and is not recommended. The Spears® Limited Lifetime Warranty (located on the back cover of this manual) does not cover problems occurring within the piping system as the direct result of non-use of Spears® **LabWaste**™ system products.

Sample Engineering Specification

Special drainage systems for corrosive chemical or acid waste shall be manufactured from CPVC Type IV, ASTM Cell Classification 23447. All pipe, fittings and solvent cement shall be manufactured in accordance with ASTM F 2618 and certified by NSF International for corrosive waste end use (NSF® cw). All pipe and molded fittings shall be CAN/ULC S102.2 Listed for Surface Burning Characteristics with a flame spread of less than 25 and a smoke development of less than 50 as designated on the original package labeling for fittings and on the pipe print string marking. All pipe markings shall be accompanied by a yellow stripe for identification of CPVC chemical waste system. All fittings shall be CPVC drainage patterns meeting the requirements of ASTM D 3311 and specialty patterns according to the manufacturer's specifications. Joining method for pipe and fittings shall be solvent cement welding. Solvent cement shall be a “one-step” primerless type CPVC cement designated by the system manufacturer, specially formulated for resistance to corrosive chemicals and manufactured in accordance with ASTM F 493, as specified in ASTM F 2618. Mechanical connections for special equipment connection or transition to other system materials shall be as specified by the CPVC system manufacturer. All pipe, fittings, and cement shall be supplied together as a complete system. Installation shall be in accordance with the manufacturer's instructions and all applicable codes. Special drainage system to be Spears® **LabWaste**™ CPVC Corrosive Waste Drainage Systems manufactured by Spears® Manufacturing Company.

LabWaste™ CPVC Technical Information & Installation Guide



P095 Duriron Transition Fitting

Mechanical Joint x Pipe Size

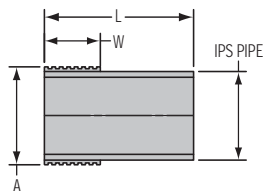

For connection to Duriron system. Requires duriron mechanical joint coupling.

Part Number	Size	A	L	W
P095-015C	1-1/2	1-3/16	4	1-3/8
P095-020C	2	2-5/8	4	1-1/2
P095-030C	3	3-3/4	4	1-7/8
P095-040C	4	4-3/4	4	2-5/16

P096 Grooved Coupling

Grv x Soc

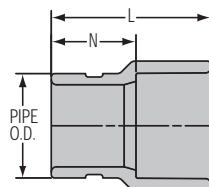

Part Number	Size	L	N
P096-015C	1-1/2	2-15/16	1-1/2
P096-020C	2	3-1/16	1-9/16
P096-030C	3	3-9/16	1-11/16
P096-040C	4	4-1/2	2-1/4
P096-060C	6	5-3/8	2-3/8

P097 Duriron Transition Coupling

Spig x Caulk Joint

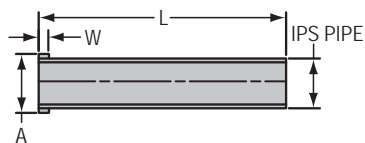

For connection to Duriron system. Requires packing and plastic lead. **Warning:** Do not use hot lead or oiled Oakum.

Part Number	Size	A	L	W
P097-015C	1-1/2	2-1/4	12	1/2
P097-020C	2	2-7/8	12	1/2
P097-030C	3	4-3/16	12	1/2
P097-040C	4	5-1/4	12	1/2

P097 Duriron Transition Coupling (continued)

Spig x Caulk Joint

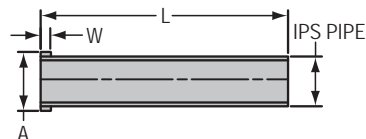

For connection to Duriron system. Requires packing and plastic lead. **Warning:** Do not use hot lead or oiled Oakum.

Part Number	Size	A	L	W
P097-060C	6	7-9/16	12	1/2
P097-080C	8	9-11/16	12	1/2

P098 Glass Transition Coupling

Spig x Clamp

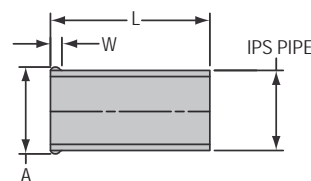

For connection to glass system. Requires use of clamp from glass system manufacturer.

Part Number	Size	A	L	W
P098-015C	1-1/2	2-1/16	4	1/4
P098-020C	2	2-1/16	5	1/4
P098-030C	3	3-11/16	6	5/16
P098-040C	4	4-27/32	6	5/16
P098-060C	6	7-1/8	6	1/2

P099 Transition Coupling

H x Compression

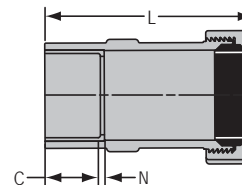

For connection to PP or PVDF systems. Requires Safety Retaining Groove Tool. Contact Spears®.

Part Number	Size	C	L	N
P099-015C	1-1/2	1-3/8	5-1/8	3/32
P099-020C	2	1-1/2	5-3/4	1/8
P099-030C	3	1-7/8	10-5/16	3/16
P099-040C	4	2-1/4	11-5/32	7/32
P099-060C	6	3	13-3/8	9/32



LabWaste™ CPVC Technical Information & Installation Guide

P100 Coupling

H x H

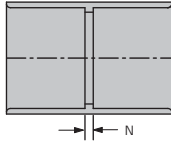

Part Number	Size	N
P100-015C	1-1/2	1/8
P100-020C	2	1/8
P100-030C	3	3/16
P100-040C	4	1/4
P100-060C	6	1/4
P100-080C	8	1/4
P100-100C	10	3/8
P100-120C	12	3/8
P100-140C	14	3/8

P102 Increaser Reducer

(continued)

H x H

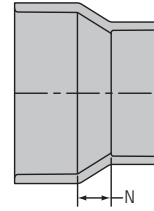

Part Number	Size	N
P102-532C	6x4	1-7/16
P102-582C	8x4	2-11/32
P102-585C	8x6	1-11/32
P102-624C	10x4	3-3/8
P102-626C	10x6	2-3/16
P102-628C	10x8	1-9/32
P102-666C	12x6	3-9/32
P102-668C	12x8	2-1/4

P101 Female Adapter

FPT x H

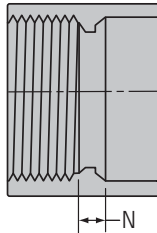

Part Number	Size	N
P101-015C	1-1/2	1/4
P101-020C	2	1/4
P101-030C	3	5/16
P101-040C	4	3/8
P101-060C	6	15/32

Pipe Increaser - Eccentric Reducer

H x H

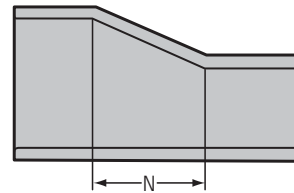

Part Number	Size	N
P102-338EC	3x2	2-15/32

P102 Increaser Reducer

H x H

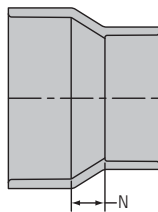

Part Number	Size	N
P102-251C	2x1-1/2	11/16
P102-337C	3x1-1/2	1-3/32
P102-338C	3x2	15/16
P102-420C	4x2	1-3/4
P102-422C	4x3	15/16
P102-530C	6x3	1-15/16

P103P Trap Adapter - Male

Spig x Slip with Plastic Nut

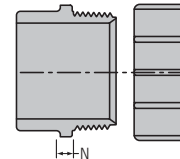

Part Number	Size	N
P103P-015C	1-1/2	3/16
P103P-020C	2	3/16

LabWaste™ CPVC Technical Information & Installation Guide



P104R Trap Adapter - Female w/1-1/2 Plastic Nut & Washer and 1-1/2x1-1/4 Washer

H x Slip w/Plastic Nut

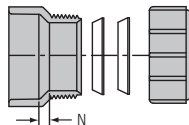

Part Number	Size	N
P104R-015C	1-1/2	3/16

P104X Trap Adapter - Female

H x Slip w/ Chrome Nut & Washer

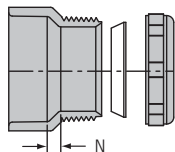

Part Number	Size	N
P104X-015C	1-1/2	3/16

P105 Cleanout Adapter

Spig x FPT

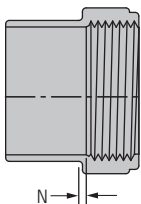

Part Number	Size	N
P105-015C	1-1/2	5/32
P105-020C	2	1/4
P105-030C	3	11/32
P105-040C	4	1/4
P105-060C	6	11/32
P105-080C	8	13/32

P105X Cleanout Adapter with Square Head Plug

Spig x FPT

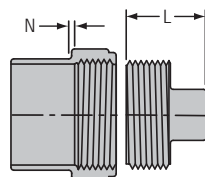

SEE PART NO. P105 AND P106

P106 Square Head Cleanout Plug

MPT

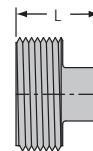

Part Number	Size	L
P106-015C	1-1/2	1-3/8
P106-020C	2	1-5/16
P106-030C	3	1-25/32
P106-040C	4	1-7/8
P106-060C	6	1-15/16
P106-080C	8	2-1/8

P107 Flush Bushing

Spig x H

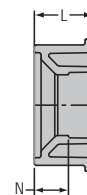

Part Number	Size	L	N
P107-251C	2x1-1/2	1-1/16	7/32
P107-337C	3x1-1/2	1-3/4	1
P107-338C	3x2	1-25/32	1
P107-420C	4x2	2	1-3/16
P107-422C	4x3	2	1/2
P107-530C	6x3	3-23/32	2-11/32
P107-532C	6x4	3-7/16	1-11/16
P107-582C	8x4	4-9/16	2-13/16
P107-585C	8x6	4-19/32	1-9/16

P109 Male Adapter

MPT x H

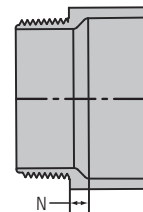

Part Number	Size	N
P109-169C	1-1/4x1-1/2	3/16
P109-015C	1-1/2	3/16
P109-020C	2	3/16
P109-030C	3	3/8
P109-040C	4	3/8
P109-060C	6	11/16



LabWaste™ CPVC Technical Information & Installation Guide

P110 Counter Sunk Cleanout Plug MPT

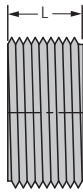

Part Number	Size	L
P110-015C	1-1/2	5/8
P110-020C	2	5/8
P110-030C	3	3/4
P110-040C	4	7/8
P110-060C	6	31/32

P116 Cap Socket

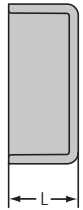

Part Number	Size	L
P116-015C	1-1/2	15/16
P116-020C	2	1
P116-030C	3	1-3/4
P116-040C	4	2
P116-060C	6	3-9/32
P116-080C	8	6-3/8

P119 No-Hub Adapter S x H

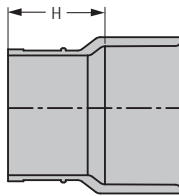

Part Number	Size	H
P119-015C	1-1/2	1-9/16
P119-020C	2	1-5/8
P119-030C	3	1-13/16
P119-040C	4	1-7/8

P123 Hub Adapter H x S

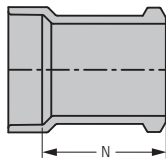

For connection to Cast Iron system. Requires packing and plastic lead. **Warning:** Do not use hot lead or oiled Oakum.

Part Number	Size	N
P123-020C	2	4-5/8
P123-030C	3	5-5/8

P130 Repair Coupling H x H



Part Number	Size	L
P130-030C	3	3-7/32
P130-040C	4	3-13/16

P300 1/4 Bend 90° Ell) H x H

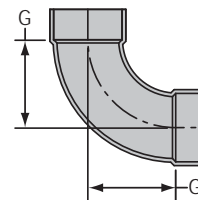

Part Number	Size	G
P300-015C	1-1/2	1-11/16
P300-020C	2	2-9/32
P300-030C	3	3
P300-040C	4	3-7/8
P300-060C	6	5
P300-080C	8	6
P300-100C	10	9-29/32
P300-120C	12	10-29/32

P300S 1/4 Bend w/Side Inlet (90° Ell) All Hub

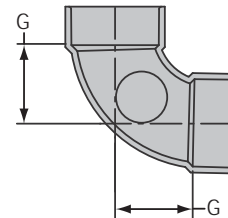

Part Number	Size	G
P300S-338C	3x3x2	3-11/32

P302 1/4 Bend, Street (90° Street Ell) H x Spig

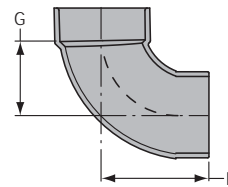

Part Number	Size	G	H
P302-015C	1-1/2	1-9/16	2-13/32
P302-020C	2	2-7/32	3-5/32
P302-030C	3	3-3/16	4-9/16
P302-040C	4	3-7/8	5-5/8

LabWaste™ CPVC Technical Information & Installation Guide



P302 1/4 Bend, Street (continued)

(90° Street EII)
H x Spig

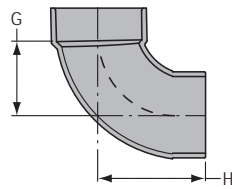

Part Number	Size	G	H
P302-060C	6	5	8-11/32
P302-080C	8	6	10-1/2
P302-100C	10	9-29/32	15-3/8
P302-120C	12	10-15/16	17-3/8

P319 1/6 Bend (60° EII)

H x H

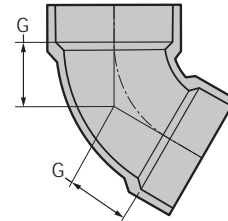

Part Number	Size	G
P319-015C	1-1/2	1-1/16
P319-020C	2	1-3/8
P319-030C	3	1-11/16
P319-040C	4	2-5/32
P319-060CF	6	4-9/16

P303 1/4 Bend with Low Heel Inlet

H x H x H

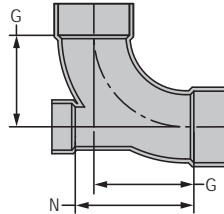

Part Number	Size	G	N
P303-338C	3x3x2	2-27/32	4-5/32
P303-420C	4x4x2	3-5/16	5

P320 1/6 Bend, Street (60° Street EII)

H x Spig

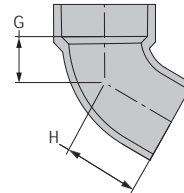

Part Number	Size	G	H
P320-015C	1-1/2	1-1/16	1-3/4
P320-020C	2	1-5/8	2-1/4
P320-030C	3	1-11/16	3-1/16
P320-040C	4	2-5/32	3-19/32

P304 1/4 Bend, Long Sweep (90° LS EII)

H x H

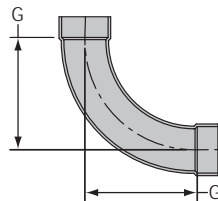

Part Number	Size	G
P304-015C	1-1/2	2-3/4
P304-020C	2	3-3/32
P304-030C	3	4-5/32
P304-040C	4	5-25/32
P304-060C	6	8-29/32

P321 1/8 Bend (45° EII)

H x H

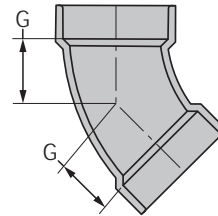

Part Number	Size	G
P321-015C	1-1/2	1-1/8
P321-020C	2	1-9/16
P321-030C	3	1-23/32
P321-040C	4	2-1/8
P321-060C	6	2-1/16
P321-080C	8	2
P321-100C	10	2-5/8
P321-120C	12	3-1/8

P309 Long Sweep 1/4 Bend, Street (90° LS Street EII)

H x Spig

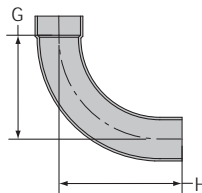

Part Number	Size	G	H
P309-015C	1-1/2	2-3/4	3-11/32
P309-020C	2	3-9/32	4-3/32
P309-030C	3	4-1/8	5-23/32
P309-040C	4	5-1/32	6-7/16
P309-060C	6	8-31/32	11-29/32



LabWaste™ CPVC Technical Information & Installation Guide

P323 1/8 Bend, Street (45° Street Ell)

H x Spig

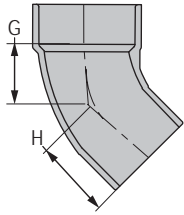

Part Number	Size	G	H
P323-015C	1-1/2	31/32	1-13/16
P323-020C	2	1-9/32	2-5/16
P323-030C	3	1-7/8	3-1/8
P323-040C	4	2-3/16	3-15/16
P323-060C	6	1-29/32	5-1/16
P323-080C	8	3-1/8	6-1/2

P327 Double 1/4 Bend (3 Way Ell)

All Hub

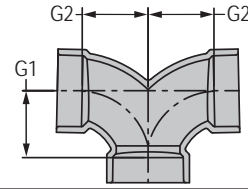

Part Number	Size	G1	G2
P327-015C	1-1/2	1-3/4	1-3/4
P327-020C	2	2-5/16	2-5/16
P327-030C	3	3-1/16	3-1/16
P327-040C	4	3-29/32	3-29/32
P327-241C	2x1-1/2x1-1/2	1-3/8	4-1/2

P324 1/16 Bend (22-1/2 Ell)

H x H

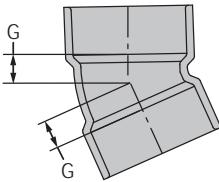

Part Number	Size	G
P324-015C	1-1/2	1/2
P324-020C	2	11/16
P324-030C	3	13/16
P324-040C	4	1
P324-060C	6	1-5/16
P324-080C	8	1-11/32

P331 Vent Ell

H x H

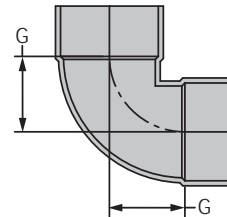

Part Number	Size	G
P331-015C	1-1/2	1-3/16
P331-020C	2	1-1/2
P331-030C	3	1-7/8
P331-040C	4	2-5/16
P331-060C	6	3-15/32

P326 1/16 Bend, Street (22-1/2° Street Ell)

H x Spig

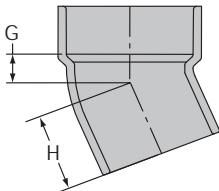

Part Number	Size	G	H
P326-015C	1-1/2	1/2	1-1/4
P326-020C	2	11/16	1-1/2
P326-030C	3	13/16	2-5/16
P326-040C	4	1	2-3/4
P326-060C	6	1-3/8	4-1/2
P326-080C	8	1-3/4	5-5/8

P333 Vent Ell, Street

H x Spig

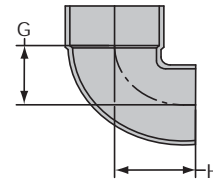

Part Number	Size	G	H
P333-015C	1-1/2	1-3/16	2
P333-020C	2	1-1/2	2-1/8
P333-030C	3	1-7/8	3-5/8
P333-040C	4	4-3/16	4-7/16

LabWaste™ CPVC Technical Information & Installation Guide



P400 Sanitary Tee

All Hub

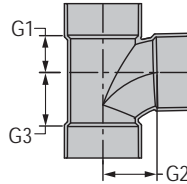

Part Number	Size	G1	G2	G3
P400-015C	1-1/2	25/32	1-9/16	1-9/16
P400-020C	2	1-11/32	2-5/16	2-5/16
P400-030C	3	1-13/16	2-7/8	2-7/8
P400-040C	4	2-1/32	3-11/16	3-11/16
P400-060C	6	3-7/16	5-1/32	5-1/32
P400-080C	8	4-13/32	6-1/16	6-1/16
P400-100C	10	5-17/32	9-31/32	9-29/32
P400-120C	12	6-1/2	10-31/32	11-1/32

P401 Sanitary Tee, Reducing

All Hub

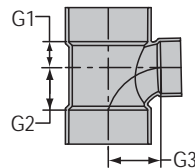

Part Number	Size	G1	G2	G3
P401-241C	2x1-1/2x1-1/2	1-3/16	1-15/16	2-3/16
P401-251C	2x2x1-1/2	1-1/4	1-27/32	2-3/16
P401-257C	2x1-1/2x2	1-3/8	2-5/16	2-5/16
P401-337C	3x3x1-1/2	15/16	1-3/4	2-1/2
P401-338C	3x3x2	31/32	1-29/32	2-13/16
P401-420C	4x4x2	7/8	1-27/32	3-5/32
P401-422C	4x4x3	1-11/16	3	3-1/2
P401-532C	6x6x4	2-1/8	3-19/32	4-11/16
P401-582C	8x8x4	4-17/32	5-7/8	8-7/8

P403 Sanitary Tee, Street

S x H x H

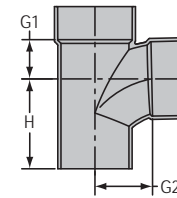

Part Number	Size	G1	G2	H
P403-015C	1-1/2	13/16	1-17/32	2-7/16
P403-030C	3	1-7/8	2-15/16	4-3/8
P403-040C	4	2-1/4	3-7/8	5-5/8
P403-080C	8	4-3/8	5-31/32	9-13/32
P403-100C	10	5-19/32	9-1/2	14-19/32
P403-120C	12	6-15/32	11-1/32	16-9/32

P404 Sanitary Tee, Street, Reducing

S x H x H

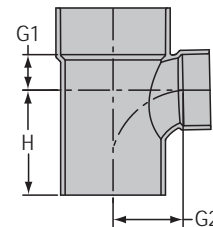

Part Number	Size	G1	G2	H
P404-241C	2x1-1/2x1-1/2	1-7/32	2-7/32	2-9/16
P404-251C	2x2x1-1/2	1-9/32	2-3/16	2-1/2
P404-337C	3x3x1-1/2	13/16	2-15/32	2-15/16
P404-338C	3x3x2	1-1/16	2-3/4	3-7/32

P428 Double Sanitary Tee

All HUB

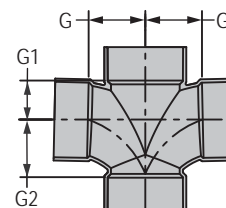

Part Number	Size	G	G1	G2
P428-015C	1-1/2	1-3/4	1	1
P428-020C	2	2-7/8	1-25/32	1-25/32
P428-030C	3	3-1/16	1-13/16	1-13/16
P428-040C	4	3-7/8	2-1/4	2-1/4



LabWaste™ CPVC Technical Information & Installation Guide

P429 Double Sanitary Tee, Reducing

All Hub

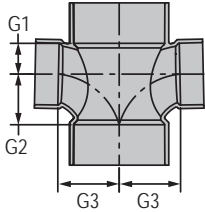

Part Number	Size	G1	G2	G3
P429-241C	2x1-1/2x1-1/2x1-1/2	1-3/16	1-7/8	2-1/16
P429-251C	2x2x1-1/2x1-1/2	1-1/8	1-7/8	2-1/8
P429-337C	3x3x1-1/2x1-1/2	15/16	1-3/4	4
P429-338C	3x3x2x2	1-3/16	2-1/8	2-7/8
P429-419C	4x4x1-1/2x1-1/2	1-1/16	2	5-1/16
P429-420C	4x4x2x2	1-1/8	2-1/16	5-1/16
P429-422C	4x4x3x3	1-3/4	3	5-1/16

P441 Vent Tee

All Hub

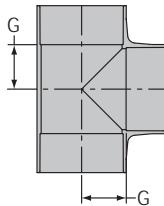

Part Number	Size	G
P441-015C	1-1/2	1-5/32
P441-030C	3	1-29/32
P441-040C	4	2-3/8
P441-060C	6	3-5/8

P444X Cleanout Tee w/Plug

H x H x FPT

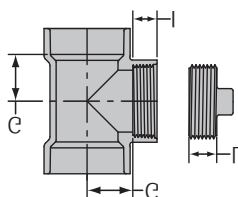

SEE PART NO. P445 AND P106

P445 Cleanout Tee

H x H x FPT

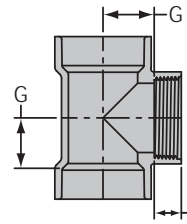

Part Number	Size	G	I
P445-015C	1-1/2	1-1/8	5/8
P445-020C	2	1-13/32	5/8
P445-030C	3	1-7/8	3/4
P445-040C	4	2-7/16	7/8
P445-060C	6	3-1/2	1

P445X Cleanout Tee with Counter Sunk Plug

H x H x FPT

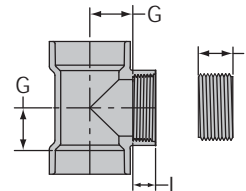

SEE PART NO. P445 AND P110

P448 2-Way Cleanout

ALL HUB

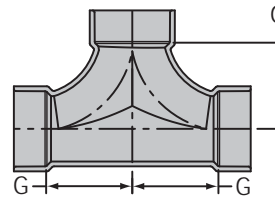

Part Number	Size	G
P448-030C	3	4
P448-040C	4	4-13/16

LabWaste™ CPVC Technical Information & Installation Guide



P500 Double Fixture Fitting

All Hub

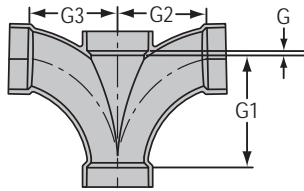

Part Number	Size	G	G1	G2	G3
P500-020C	2x2x2x2	9/16	3-9/16	3-5/16	3-5/16
P500-241C	2x1-1/2x1-1/2x1-1/2	3/8	3-1/8	2-7/8	2-7/8
P500-251C	2x2x1-1/2x1-1/2	1/8	3-1/4	2-25/32	2-25/32
P500-338C	3x2x3x3	1/2	6-9/32	4-7/8	4-7/8
P500-030C	3x3x3x3	1/2	6-9/32	4-29/32	4-29/32

P503 Combination Wye and 1/8 Bend (Two Piece)

All Hub

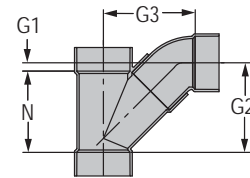

Part Number	Size	G1	G2	G3	N
P503-060C	6	31/32	10-31/32	11-11/32	10
P503-080C	8	1-1/2	16	16	14-1/2
P503-100C	10	2-1/2	21-7/8	17-15/16	16-9/16

P501 Combination Wye and 1/8 Bend (Long Turn Tee Wye)

All Hub

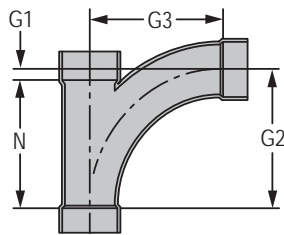

Part Number	Size	G1	G2	G3	N
P501-015C	1-1/2	13/32	3-7/8	3-7/8	3-15/32
P501-020C	2	11/16	5-1/8	5-1/8	4-7/16
P501-030C	3	1-1/16	7-9/16	7-9/16	6-1/2
P501-040C	4	1-1/2	10	10	8-1/2

P504 Combination Wye and 1/8 Bend, Reducing (Two Piece)

All Hub

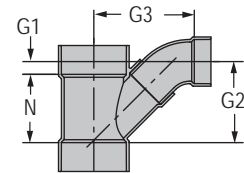

Part Number	Size	G1	G2	G3	N
P504-241C	2x1-1/2	3/32	4-7/16	4-15/32	4-5/16
P504-528C	6x2	15/32	7-9/16	8-27/32	7-3/32
P504-530C	6x3	5/8	7-1/4	8-29/32	7-3/32
P504-532C	6x4	1-5/16	8-3/32	10-3/32	6-27/32
P504-582C	8x4	1-1/4	9-1/4	11-1/8	8
P504-585C	8x6	1	11-5/16	12-7/16	10-7/16
P504-623C	10x3	2-3/8	11-1/16	13-15/16	11-1/16
P504-624C	10x4	1-3/8	12-3/16	14-5/8	10-13/16
P504-626C	10x6	2-1/2	11-3/4	14-1/16	10-13/16
P504-628C	10x8	2-1/2	14-1/2	15-1/2	13-9/16
P504-668C	12x8	3	20-1/8	19-1/8	19-1/8
P504-670C	12x10	3	19-13/16	19-1/2	19-1/8

P502 Combination Wye and 1/8 Bend, Reducing (Long Turn Tee Wye)

All Hub

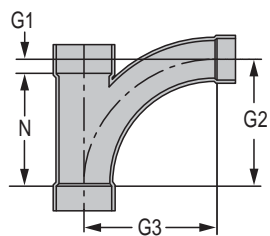

Part Number	Size	G1	G2	G3	N
P502-251C	2x2x1-1/2	7/16	3-15/16	4-3/16	3-1/2
P502-337C	3x3x1-1/2	7/16	3-15/16	4-3/4	3-1/2
P502-338C	3x3x2	11/16	5-1/8	5-11/16	4-7/16
P502-420C	4x4x2	7/32	4-1/2	6-1/8	4-3/32
P502-422C	4x4x3	1-1/16	7-9/16	8-1/16	6-1/2



LabWaste™ CPVC Technical Information & Installation Guide

P507 Double Combination Wye and 1/8 Bend

All Hub

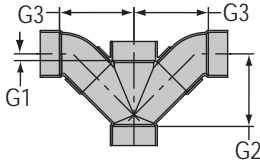

Part Number	Size	G1	G2	G3
P507-020C	2	11/16	5-9/16	5-13/16
P507-030C	3	27/32	7-11/32	7-11/32
P507-040C	4	1-1/8	8-31/32	9-7/32
P507-060C	6	1	11-1/32	11-13/32
P507-338C	3x3x2x2	29/32	5-3/4	6-1/2
P507-422C	4x4x3x3	1-1/16	7-1/2	8-1/8
P507-530C	6x6x3x3	1-1/32	10-7/8	10-7/8
P507-532C	6x6x4x4	1-23/32	11-5/8	12-5/32

P601 45° Wye, Reducing

All Hub

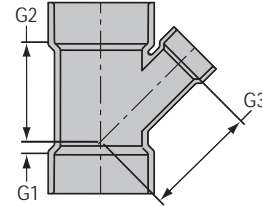

Part Number	Size	G1	G2	G3
P601-241C	2x1-1/2x1-1/2	3/4	2-15/16	2-15/16
P601-251C	2x2x1-1/2	13/16	3-15/32	3-17/32
P601-337C	3x3x1-1/2	1/2	3-25/32	4-3/8
P601-338C	3x3x2	7/8	4-3/32	4-17/32
P601-419C	4x4x1-1/2	3/8	3-9/32	4-3/8
P601-420C	4x4x2	9/32	4-1/4	5-5/16
P601-422C	4x4x3	21/32	5-1/2	5-29/32
P601-528C	6x6x2	7/32	6-7/8	8-3/8
P601-530C	6x6x3	1-1/8	6	6-7/8
P601-532C	6x6x4	23/32	6-3/16	7-1/8
P601-578C	8x8x2	3/8	7-5/8	9-13/16
P601-580C	8x8x3	7/32	9-1/8	7-11/32
P601-582C	8x8x4	3/8	6-31/32	8-5/16
P601-585C	8x8x6	1	9-1/2	9-13/16
P601-626C	10x10x6	9/32	10-31/32	11-31/32
P601-628C	10x10x8	1-1/16	12-3/8	11-27/32
P601-661C ¹	12x12x2	3	16-3/16	23-1/2
P601-663C ¹	12x12x3	3	16-3/16	22-7/8
P601-664C ¹	12x12x4	3	16-3/16	22-3/8
P601-666C ¹	12x12x6	3	16-3/16	21-1/8
P601-670C ¹	12x12x10	2-15/16	16-3/16	17-3/16

¹Sized with Bushing

P600 45° Wye

All Hub

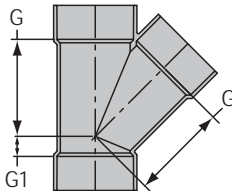

Part Number	Size	G	G1
P600-015C	1-1/2	2-7/8	1-3/32
P600-020C	2	3-5/8	7/8
P600-030C	3	5	1-5/8
P600-040C	4	6-1/4	1-7/8
P600-060C	6	8	1-3/8
P600-080C	8	11-5/16	2
P600-100C	10	14-1/32	2-7/16
P600-120C	12	16-7/16	2-5/32

P611 Double Wye

All Hub

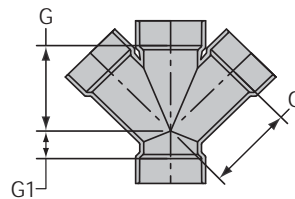

Part Number	Size	G	G1
P611-015C	1-1/2	2-7/8	1-1/8
P611-020C	2	3-9/16	1-3/8
P611-030C	3	4-15/16	1-5/8
P611-040C	4	6-11/32	1-27/32
P611-060C	6	8-5/16	1-25/32

LabWaste™ CPVC Technical Information & Installation Guide



P612 Double Wye, Reducing

All Hub

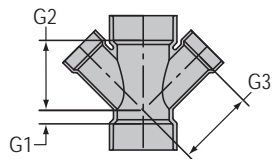

Part Number	Size	G1	G2	G3
P612-241C	2x1-1/2x1-1/2x1-1/2	25/32	3-3/8	4-3/16
P612-251C	2x2x1-1/2x1-1/2	1-1/16	3-5-16	3-7/16
P612-337C	3x3x1-1/2x1-1/2	1/2	3-3/4	4-5/16
P612-338C	3x3x2x2	7/8	4-1/16	4-5/8
P612-420C	4x4x2x2	3/8	4-5/8	5-17/32
P612-422C	4x4x3x3	1-1/2	5-1/32	5-9/32
P612-532C	6x6x4x4	3/16	6-11/16	7-7/16

P700 Return Bend

H x H

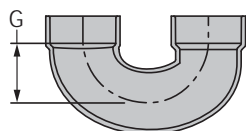

Part Number	Size	G
P700-015C	1-1/2	1-13/32
P700-020C	2	2-3/8
P700-030C	3	3
P700-040C	4	3-7/16
P700-060C	6	5

P704P Tail Piece Adapter

Spig x Slip w/Plastic Nut

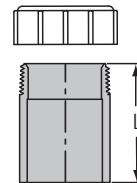

Part Number	Size	L
P704P-015C	1-1/2	2-1/2

P705 S-Trap

H x H

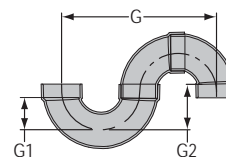

Part Number	Size	G	G1	G2
P705-015C	1-1/2	7-1/2	1-3/4	2-3/8
P705-020C	2	14-1/2	2-3/8	3-13/32
P705-030C	3	15-1/2	3-3/16	4-7/16
P705-040C	4	19-1/16	3-7/8	5-9/16

P705R Running Trap

H x H

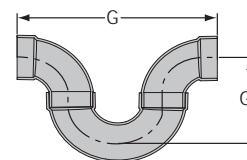

Part Number	Size	G	G1
P705R-015C	1-1/2	8	3-3/4
P705R-020C	2	12-1/2	5-7/16
P705R-030C	3	17-1/8	7-21/32
P705R-040C	4	20-7/8	9-9/32



LabWaste™ CPVC Technical Information & Installation Guide

P706X P-Trap

H x H

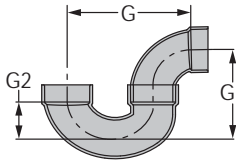

Part Number	Size	G	G1	G2
P706X-015C	1-1/2	4-3/16	3-29/32	1-13/32
P706X-020C	2	6-7/16	4-21/32	2-11/32
P706X-030C	3	8-11/16	6-15/16	3-1/32
P706X-040C	4	11-1/32	8-1/8	3-23/32
P706X-060C	6	18-25/32	14-3/4	5-13/16
P706X-080C	8	22	17	6-3/4

P707X P-Trap w/Cleanout

H x H

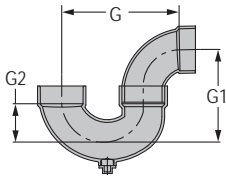

Part Number	Size	G	G1	G2
P707X-015C	1-1/2	4-3/16	3-21/32	1-7/32

P708P P-Trap w/Plastic Nut (Union Connection)

H x H

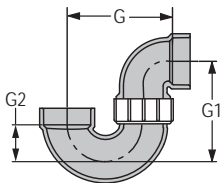

Part Number	Size	G	G1	G2
P708P-015C	1-1/2	4-1/4	3-3/4	1-9/16
P708P-020C	2	7-1/4	4-3/8	2-13/32

P711P L.A. Pattern P-Trap w/Plastic Nut (Union Connection w/Slip Joint)

Slip x H w/Plastic Nut

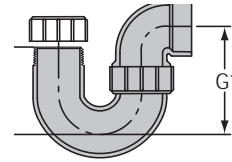

Part Number	Size	G	G1	G2
P711P-015C	1-1/2	4-11/32	3-3/4	3-1/2

P712 Jar Trap

Spig x H

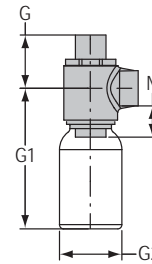

Part Number	Size	G	G1	G2	N
P712-015C	1-1/2	3-3/16	8-1/4	3-29/32	1-7/8

P712P Jar Trap w/Tail Piece Adapter

Slip x H

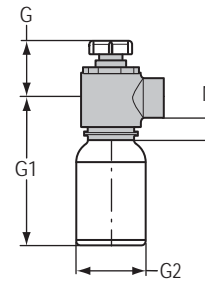

Part Number	Size	G	G1	G2	N
P712P-015C	1-1/2	3-5/16	8-1/4	3-7/8	1-3/4

LabWaste™ CPVC Technical Information & Installation Guide



Flange - Van Stone Style

Soc

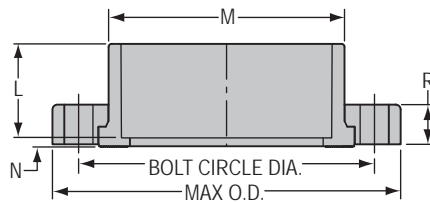

Part Number	Size	L	M	N	R	No. of Bolt Holes	Bolt Circle Dia.	Bolt Size	Min. Bolt Length	Max O.D.
854-015C	1-1/2	1-17/32	2-7/16	3/16	3/4	4	3-7/8	1/2	2-1/2	5
854-020C	2	1-11/16	2-15/16	3/16	13/16	4	4-3/4	5/8	3	6
854-030C	3	2-1/8	4-1/4	1/4	1-1/16	4	6	5/8	3-1/4	7-1/2
854-040C	4	2-1/2	5-1/4	1/4	1-1/8	8	7-1/2	5/8	3-1/2	9
854-060C	6	3-3/8	7-9/16	7/16	1-9/32	8	9-1/2	3/4	4	11
854-080C	8	4-3/8	9-5/16	9/32	1-3/8	8	11-3/4	3/4	4-1/2	13-1/2
854-100C	10	5-11/16	11-3/4	21/32	1-5/8	12	14-1/4	7/8	5	16
854-120C	12	7-1/4	13-3/4	5/8	1-1/2	12	17	7/8	5	19
854-140C	14	7-1/2	15-1/2	1/2	2	12	18-3/4	1	5-1/2	21
854-160C	16	8-3/4	17-3/4	3/4	2-3/8	16	21-1/4	1	6-1/2	23-1/2

P720 Drum Trap

H x H

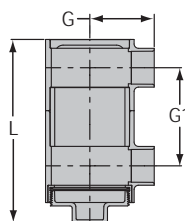

Part Number	Size	G	G1	L
P720-015C	1-1/2	3-5/8	5-11/16	10-5/8
P720-020C	2	3-7/8	5	10-3/8
P720-030C	3	4-1/2	6-3/4	13-7/16
P720-040C	4	4-3/8	8-1/4	15-11/16

Waste Assembly

Sink Outlet

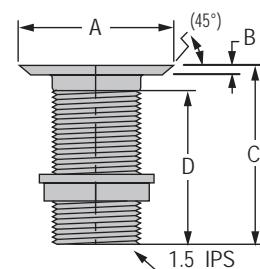

Part Number	Size	A	B	C	D
LWWA-1	1-1/2	2-7/16	9/32	4-9/32	3-27/32



LabWaste™ CPVC Technical Information & Installation Guide

LW1500 Floor Drain with CPVC Adjustable Top w/5" Round Gate

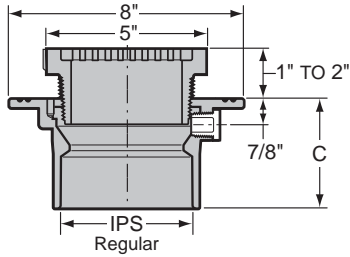

Part Number Regular	Size	IPS	C
LW1500-015C	1-1/2x5	1-1/2	4-3/16
LW1500-020C	2x5	2	4
LW1500-030C	3x5	3	4
LW1500-040C	4x5	4	3-3/4

LW150M Floor Drain with CPVC Adjustable Top w/5" Round Gate & Membrane Collar

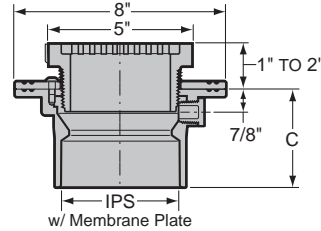

Part Number Membrane Plate	Size	C
LW150M-015C	1-1/2x5	4-3/16
LW150M-020C	2x5	4
LW150M-030C	3x5	4
LW150M-040C	4x5	3-3/4

LW1520 Floor Drain with CPVC Adjustable Top w/5" Round Gate & Strainer

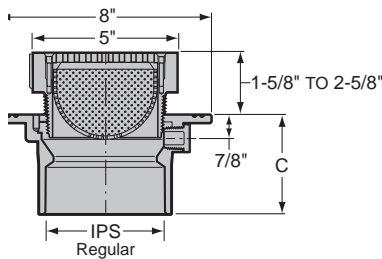

Part Number	Size	IPS	C
LW1520-015C	1-1/2x5	1-1/2	4-3/16
LW1520-020C	2x5	2	4
LW1520-030C	3x5	3	4
LW1520-040C	4x5	4	3-3/4

LW152M Floor Drain with CPVC Adjustable Top w/5" Round Gate, Strainer & Membrane Collar

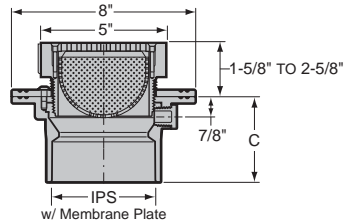

Part Number Regular	Size	IPS	C
LW152M-015C	1-1/2x5	1-1/2	4-3/16
LW152M-020C	2x5	2	4
LW152M-030C	3x5	3	4
LW152M-040C	4x5	4	3-3/4

LabWaste™ CPVC Technical Information & Installation Guide



Floor Drain with Stainless Steel Adjustable Top w/Round Grate

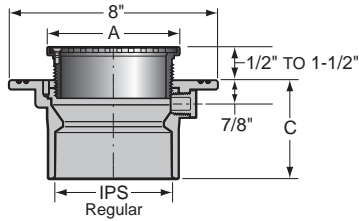

Part Number Regular	Size	A, Nom	IPS	C
LW1500-015S	1-1/2x5	5	1-1/2	4-3/16
LW1600-015S	1-1/2x6	6	1-1/2	4-3/16
LW1700-015S	1-1/2x7	7	1-1/2	4-3/16
LW1800-015S	1-1/2x8	8	1-1/2	4-3/16
LW1500-020S	2x5	5	2	4
LW1600-020S	2x6	6	2	4
LW1700-020S	2x7	7	2	4
LW1800-020S	2x8	8	2	4
LW1500-030S	3x5	5	3	4
LW1600-030S	3x6	6	3	4
LW1700-030S	3x7	7	3	4
LW1800-030S	3x8	8	3	4
LW1500-040S	4x5	5	4	3-3/4
LW1600-040S	4x6	6	4	3-3/4
LW1700-040S	4x7	7	4	3-3/4
LW1800-040S	4x8	8	4	3-3/4

Floor Drain with Stainless Steel Adjustable Top w/Round Grate & Membrane Collar

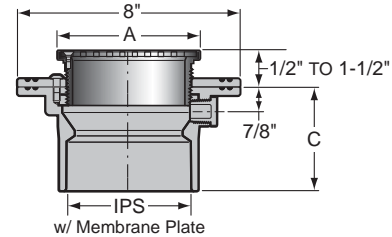

Part Number Membrane	Size	A, Nom	IPS	C
LW150M-015S	1-1/2x5	5	1-1/2	4-3/16
LW160M-015S	1-1/2x6	6	1-1/2	4-3/16
LW170M-015S	1-1/2x7	7	1-1/2	4-3/16
LW180M-015S	1-1/2x8	8	1-1/2	4-3/16
LW150M-020S	2x5	5	2	4
LW160M-020S	2x6	6	2	4
LW170M-020S	2x7	7	2	4
LW180M-020S	2x8	8	2	4
LW150M-030S	3x5	5	3	4
LW160M-030S	3x6	6	3	4
LW170M-030S	3x7	7	3	4
LW180M-030S	3x8	8	3	4
LW150M-040S	4x5	5	4	3-3/4
LW160M-040S	4x6	6	4	3-3/4
LW170M-040S	4x7	7	4	3-3/4
LW180M-040S	4x8	8	4	3-3/4



LabWaste™ CPVC Technical Information & Installation Guide

LW1510 Floor Cleanout w/Stainless Steel Adjustable Round Top & Solid Access Cover

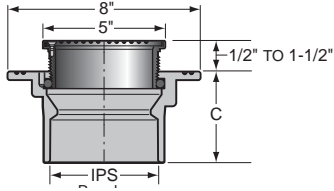

Part Number Regular	Size	IPS	C
LW1510-015S	1-1/2x5	1-1/2	4-3/16
LW1510-020S	2x5	2	4
LW1510-030S	3x5	3	4
LW1510-040S	4x5	4	3-3/4

LW151M Floor Cleanout w/Stainless Steel Adjustable Round Top, Solid Access Cover & Membrane Collar

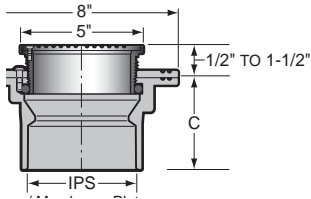

Part Number Membrane Plate	Size	IPS	C
LW151M-015S	1-1/2x5	1-1/2	4-3/16
LW151M-020S	2x5	2	4
LW151M-030S	3x5	3	4
LW151M-040S	4x5	4	3-3/4

LW LabWaste™ Pipe

10' Lengths

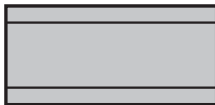

Part Number	Pipe Dia. (inches)	Avg. O.D.	Avg. I.D.	Min. Wall
LW-015	1-1/2	1.900	1.592	.145
LW-020	2	2.375	2.049	.154
LW-030	3	3.500	3.042	.216
LW-040	4	4.500	3.998	.237
LW-060	6	6.625	6.031	.280
LW-080	8	8.625	7.943	.322
LW-100	10	10.750	9.976	.365
LW-120	12	12.750	11.890	.406

One-Step CPVC Cement Yellow-Heavy Bodied



Part Number	Size
LW5-030	Quart
LW5-040	Gallon

Average Number of Joints per Quart of Solvent Cement

Pipe Diameter	Number of Joints
1-1/2"	90
2"	60
3"	40
4"	30
6"	10
8"	5
10"	2 - 3
12"	1 - 2

Note: These figures are based on laboratory tests. Due to many field variations, these should be used as a general guide only.

LabWaste™ Air Admittance Valve

Spigot

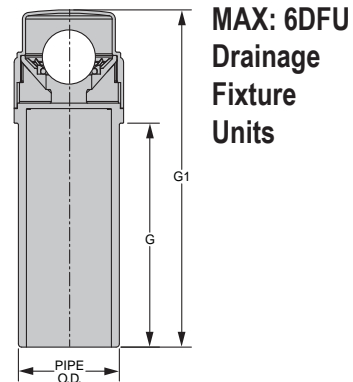

Part Number	Size	G	G1
AAV-015C	1-1/2	4-1/8	6-1/4

LabWaste™ CPVC Technical Information & Installation Guide



Standard HDPE Round Neutralization/Dilution Tanks Construction: HDPE – High Density Polyethylene

Tank Capacity US Gallions	Approx. Useable Capacity, US Gallions		Inside Dimension Dia x Ht. (in.)	Wall Thickness (in.)	Approx. Weight (lbs.)	Standard Inlet & Outlet Connection Size (in.)	Standard Fitting Connection	LabWaste™ Transition Connection Fitting	Optional Vent Connection Size (in.)	Approx. Centerline Height (in.)		
	Without Limestone	With Limestone								Inlet	Outlet	Vent
5	3	1	11 x 14	3/16	10	1-1/2 or 2	Mipt	P101	1-1/2 or 2	11	8	12
15	7	2	18 x 15	3/16	20	1-1/2 or 2	Mipt	P101	1-1/2 or 2	11	8	12
30	19	6	18 x 29	3/16	35	3	Mipt	P101	2 or 3	23	19	25
55	35	12	22 x 36	3/16	50	4	Mipt	P101	3 or 4	27	23	31
100	77	26	28 x 42	1/4	85	4	Mipt	P101	3 or 4	35	31	37
150	105	35	31 x 48	1/4	100	4	Mipt	P101	3 or 4	38	34	42
175	135	45	30 x 60	1/4	125	4	Mipt	P101	3 or 4	51	47	54
200	137	46	36 x 48	1/4	125	4 or 6	Mipt/Flange	P101/854	4 or 6	38	34	42
275	186	62	42 x 48	1/4	160	4 or 6	Mipt/Flange	P101/854	4 or 6	38	34	42
300	230	76	36 x 74	5/16	175	4 or 6	Mipt/Flange	P101/854	4 or 6	61	56	65
350	243	81	48 x 48	5/16	200	4 or 6	Mipt/Flange	P101/854	4 or 6	38	34	42
500	395	132	52 x 60	3/8	225	4 or 6	Mipt/Flange	P101/854	4 or 6	51	47	54
550	447	149	48 x 72	3/8	275	4 or 6	Mipt/Flange	P101/854	4 or 6	64	60	67
650	548	183	48 x 84	3/8	375	4 or 6	Mipt/Flange	P101/854	4 or 6	75	71	76
1200	1052	351	69 x 84	3/8	600	4 or 6	Mipt/Flange	P101/854	4 or 6	74	68	76
2000 ¹	1559	521	84 x 84	1/2	850	4 or 6	Mipt/Flange	P101/854	4 or 6	74	68	76
3000 ¹	2203	735	95 x 97	1/2	1350	4 or 6	Mipt/Flange	P101/854	4 or 6	87	83	91

Standard CPVC Round Neutralization/Dilution Tanks Construction: Chlorinated Polyvinyl Chloride (CPVC)

Tank Capacity US Gallions	Approx. Useable Capacity, US Gallions		Inside Dimension Dia. x Ht. (in.)	Wall Thickness (in.)	Approx. Weight (lbs.)	Standard ² Inlet & Outlet Connection Size (in.)	Standard Fitting Connection	LabWaste™ Transition Connection Fitting ³	Optional ⁴ Vent Connection Size (in.)	Approx. Centerline Height (in.) ⁵		
	Without Limestone	With Limestone								Inlet	Outlet	Vent
5	5	3	12-3/8 x 14-11/16	3/16	20	1-1/2 or 2	Socket	Direct	1-1/2 or 2	11	8	12
15	15	7	17-11/16 x 17-1/4	3/16	35	1-1/2 or 2	Socket	Direct	1-1/2 or 2	11	8	12
30	30	18	17-5/8 x 33	3/16	54	3	Socket	Direct	2 or 3	23	18	25
55	55	35	23-1/2 x 38-1/2	1/4	70	4	Socket	Direct	3 or 4	27	23	31

Important Notes

- 1 Larger HDPE tanks may include exterior steel banding or fiberglass reinforcement for additional strength. Special ordered optional inspection manhole ports are recommended for larger tanks (includes cover with neoprene gasket, stainless steel nuts, bolts, and washers).
- 2 All tanks can be special ordered with Mipt, Flanged (CL150), and Fipt connections or varying combinations other than standard connections specified. Inlets or vents may also be custom ordered for installation in covers instead of tank sides.
- 3 For transitions from Mipt HDPE tank connections to **LabWaste™** piping use part numbers P101-xxxC, Female Adapter. CPVC tank sockets can be cemented directly to **LabWaste™** piping. For transitions from ALL flanged connections to **LabWaste™** piping use part numbers 854-xxxC, Flange (xxx = size code).
- 4 Venting is required by codes but may be accomplished either at the tank or in-line.
- 5 Neutralization tanks and tank extensions are not warranted for direct burial applications. Tanks must be properly placed and secured with no applied stresses, within a dry concrete vault with use of a protective traffic cover as deemed appropriate. However, if direct burial is used without warranty, custom centerlines must be furnished from top of cover down to fitting centerline instead of specified tank bottom to fitting centerline since tank heights can vary.



LabWaste™ CPVC Technical Information & Installation Guide

HDPE Tanks

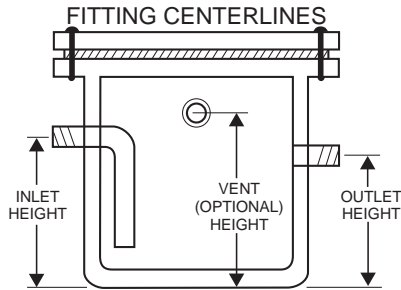
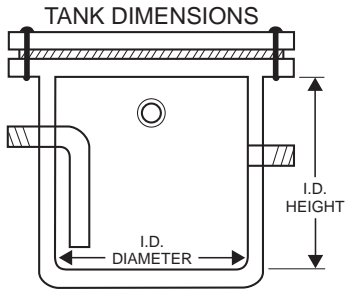

TOP VIEW
STANDARD FITTING LOCATIONS

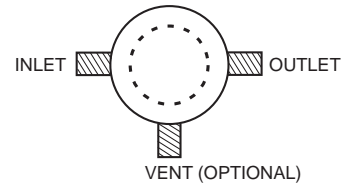

(Advise If You Want
Standard Locations Changed)

CPVC Tanks

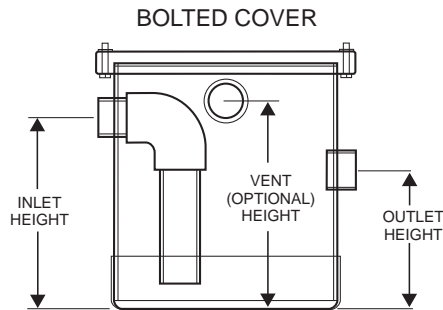
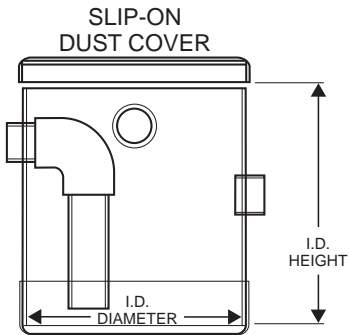

1-Gallon CPVC Dilution Tanks

Provides chemical dilution from water rinse during use. Designed for under-sink installations.
CPVC construction with Glass or PP Jar type tank.

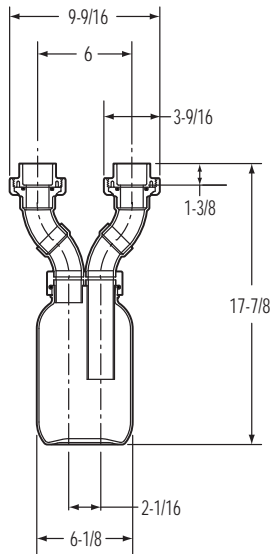
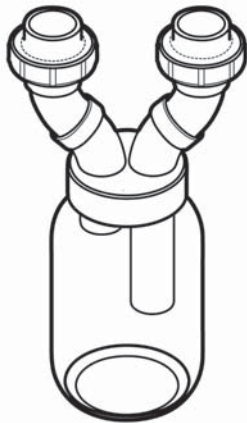

Glass

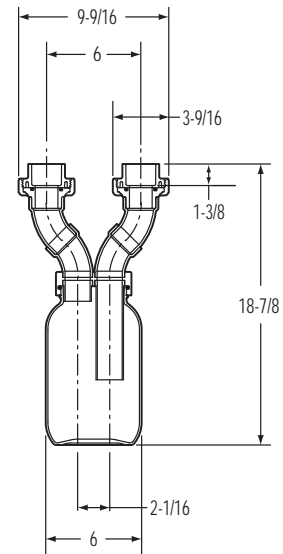

Polypropylene

LabWaste™ CPVC Technical Information & Installation Guide



Chemical Resistance Information

CPVC is inert to most acids, bases, salts, plus a wide variety of organic compounds. Application conditions including chemical concentration and temperature must be taken into consideration. Due to the many variables involved, final suitability often must be based on in-service testing.

The following Chemical Resistance Table recommendations apply only to non-pressure, laboratory drainage applications, which are those characterized as the routine disposal of a wide variety of hot and cold chemicals in relatively small quantities accompanied by water for the purpose of dilution and flushing. For use of **LabWaste™** CPVC products in continuous or dedicated chemical waste drainage systems, chemical resistance data for pressure applications must be followed. Contact Spears® Technical Services for additional information.

In many cases compatibility or solubility data is not available. While specific data may not be available, please note that virtually all aqueous solutions of chemicals used in a laboratory can be safely used with proper dilution and flushing. This includes chemicals that readily disperse in water (such as many fat-soluble vitamins and oils) that can be flushed during disposal.

This information is compiled from commercially available industry sources. It is offered in good faith and believed to be accurate at the time of its preparation, but is offered without any warranty, expressed or implied, by information sources or Spears® Manufacturing Company. These recommendations are guidelines for use and the final decision regarding material suitability must rest with the end-user.

Noted Caution Areas for CPVC

- Disposed chemicals must be properly diluted. Chemicals that individually have no effect may have an effect when used in combination. Due to the wide variety of potential chemical concentrations and combinations, testing under actual service conditions is highly recommended.
- CPVC is not recommended for use with chlorinated solvents. Most solvents are prohibited by law from disposal in drainage systems.
- Chemicals that do not normally affect CPVC may cause cracking when excessive stress is applied. Tests under applied adverse stress conditions indicate that environmental stress cracking may occur when exposed to surfactants, certain oils, or grease. Such stresses include external stresses from expansion/contraction and installation. Special consideration should be taken during design and installation to avoid unusual stresses in the piping system.
- Chemical resistance of plastics tends to decrease with an increase in chemical concentration and/or temperature. As a result, various chemicals may be safely handled in limited concentrations or within certain temperature limits. Most all aqueous solutions of water-soluble chemical not specified in the Chemical Resistance Tables can be used in CPVC drainage systems.
- While **LabWaste™** CPVC products are suitable for many continuous commercial and industrial chemical waste applications, the following Chemical Resistance Tables should **NOT** be used for these applications. Consult chemical resistance data for CPVC pressure piping to determine suitability for continuous chemical waste drainage applications.

WARNING: Hazardous material (including certain solvents and high concentrations of certain acids), are typically not discharged into lab waste piping. Laboratories routinely have specialized collection equipment and contracted disposal services for waste considered “hazardous”. Proper laboratory protocols on handling materials identified by OSHA and EPA as “hazardous” must be established and followed. Such requirements typically specify special storage and disposal apart from drainage disposal via dilution or neutralization. Even improper handling and disposal of HAZARDOUS materials by accident are subject to heavy fines by Federal, State and Local Authorities.



LabWaste™ CPVC Technical Information & Installation Guide

Chemical Resistance Tables

Resistance Rating Codes

- R** = Recommended
- C** = Use with Caution.
- N** = Not Recommended.
- = No data available

IMPORTANT NOTE: Chemical Resistance data is provide for material compatibility information purposes only and in no way addresses the legal discharge of chemicals into any waste system, some of which may be prohibited by law. Nor does the data address the compatibility of chemical mixtures, issues of hazardous decomposition, or other potentially dangerous circumstances that might be involved. Data is applicable to laboratory drainage systems only and may not be suitable for continuous service or pressure applications.

CHEMICAL	RATING	CHEMICAL	RATING	CHEMICAL	RATING
A					
Acacia, Gum Arabic	R	Ammonium Nitrate	R	Bromphenol Blue	R
Acetaldehyde	R	Ammonium Persulfate	R	Bromthymol Blue	R
Acetamide	R	Ammonium Phosphate		Butadiene	R
Acetic Acid Vapor 25%	R	Monobasic/Dibasic	R	Butane	R
Acetic Acid 60%	R	Ammonium Sulfate	R	Butyl Acetate	C
Acetic Acid 85%	R	Ammonium Sulfide	R	Butyl Alcohol	C
Acetic Acid Glacial	R	Ammonium Sulfite	R	Butyl Cellosolve	R
Acetic Anhydride	R	Ammonium Thiocyanate	R	n-Butyl Chloride	---
Acetone	R	Amyl Acetate	C	Butylene (C)	---
Acetophenone	C	Amyl Alcohol 1%	R	Butyl Phenol	C
Acetyl Chloride	R	Amyl Alcohol >1%	C	Butyl Phthalate	---
Acetylene	N	n-Amyl Chloride	C	Butyl Stearate	---
Acetylnitrile	R	Aniline	C	Butynediol	---
Acetylsalicylic acid, aspirin	R	Aniline Chlorhydrate	C	Butyric Acid	R
Acrylic Acid	R	Aniline Hydrochloride	C		
Acrylonitrile	R	Anthraquinone	R	C	
Adenine, 6-aminopurine	R	Anthraquinone		Cadium Cyanide	R
Adenosine Triphosphate	R	Sulfonic Acid	R	Calcium Acetate	R
Adipic Acid	R	Antimony Trichloride	R	Calcium Bisulfide	R
Agarose	R	Aqua Regia	R	Calcium Bisulfate	R
Alizarin stain		Argon	---	Calcium Carbonate	R
Mordant Red 11	R	Arsenic Acid	R	Calcium Chlorate	R
Alizarin Red S		Aryl Sulfonic Acid	R	Calcium Chloride	R
Mordant Red 3	R	Asorbic Acid	R	Calcium Fluoride	R
Alizarin Yellow R		L-Asparagine	R	Calcium Hydroxide	R
Mordant Orange 1	R	Asphalt	N	Calcium Hypochlorite	R
Allyl Alcohol	R			Calcium Nitrate	R
Allyl Chloride	N	B		Calcium Oxide	R
Aluminum Acetate	R	Barium Acetate	R	Calcium Sulfate	R
Aluminum Ammonium	R	Barium Carbonate	R	Camphor	---
Aluminum Chloride	R	Barium Chloride	R	Cane Sugar Liquors	R
Aluminum Fluoride	R	Barium Hydroxide	R	Caprylic Acid	---
Aluminum Hydroxide	R	Barium Nitrate	R	Carbitol	---
Aluminum Nitrate	R	Barium Sulfate	R	Carbolic Acid	R
Aluminum Oxychloride	R	Barium Sulfide	R	Carbon Dioxide Dry	R
Aluminum Potassium	R	Beer	R	Carbon Dioxide Wet	R
Aluminum Potassium Sulfate, Alum	R	Beer Sugar Liquors	R	Carbon Disulfide	C
Aluminum Sulfate	R	Benzaldehyde	R	Carbon Monoxide	R
Ammonia Anhydrous	R	Benzene	C	Carbon Tetrachloride	N
Ammonia Gas	R	Benzene Sulfonic Acid	R	Carbonic Acid	R
Ammonia Liquid	R	Benzoic Acid	R	Castor Oil	C
Ammonia Acetate	R	Benzyl Alcohol	R	Caustic Potash	R
Ammonium Bicarbonate	R	Bismuth Carbonate	R	Caustic Soda	R
Ammonium Bifluoride	R	Biuret	R	Cellosolve	C
Ammonium Bisulfide	R	Black Liquor	R	Cellosolve Acetate	R
Ammonium Bromide	R	Bleach 5%	R	Chloral Hydrate	R
Ammonium Carbonate	R	Bleach 12%	R	Chloramine	R
Ammonium Chloride	R	Blood	R	Chloric Acid	R
Ammonium Citrate	R	Borax	R	Chloric Acid 20%	R
Ammonium Dichromate	R	Boric Acid	R	Chlorine, Aqueous	R
Ammonium Dihydrogen		Brake Fluid	---	Chlorinated Water 10 PPM	R
Phosphate	R	Brine	R	Chlorinated Water Sat'd	R
Ammonium Ferric Sulfate	R	Brilliant Blue G-250	R	Chloroacetic Acid	R
Ammonium Ferrous Sulfate	R	Brilliant Blue R-250	R	Chloroacetyl Chloride	---
Ammonium Fluoride 10%	R	Brilliant Cresyl Blue	R	Chlorobenzene	N
Ammonium Fluoride 25%	R	Brilliant Green	R	Chlorobenzyl Chloride	N
Ammonium Hydroxide		Bromocresal Green	R	Chloroform	N
10% - 28%	R	Bromocresal purple	R	Chlorophenol Red	R
Ammonium Hydroxide		Bromic Acid	R	Chloropicrin	---
100%	R	Bromine Liquid	R	Chlorosulfonic Acid	R
Ammonium Iodide	R	Bromine Vapor	R	Chromic Acid 10%	R
		Bromine Water	R	Chromic Acid 30%	R
		Bromotoluene	---	Chromic Acid 40%	R



LabWaste™ CPVC Technical Information & Installation Guide

CHEMICAL	RATING
Maleic Acid	R
Malic Acid	R
Maltose	R
Manganese Chloride	R
Manganese Nitrate	R
Manganese Sulfate	R
Menthol	R
Mercuric Chloride	R
Mercuric Cyanide	R
Mercuric Sulfate	R
Mercurous Nitrate	R
Mercury	R
Methane	R
Methanol	R
DL-methionine	R
Methoxyethyl Oleate	---
Methyl Acetate	R
Methyl Acetone	R
Methyl Acrylate	---
Methyl Amine	R
Methyl Bromide	N
Methyl Cellulosolve	R
Methyl cellulose	R
Methyl Chloride	N
Methyl Chloroform	N
Methyl Ethyl Ketone	R
Methyl Formate	R
Methyl Green	R
Methyl Isobutyl Carbinol	R
Methyl Isobutyl Ketone	R
Methyl Isopropyl Ketone	R
Methyl Methacrylate	R
Methyl Red	R
Methyl Sulfate	R
Methyl Violet-2B	R
Methyl Violet-6B	R
Methylene Blue	R
Methylene Bromide	N
Methylene Chloride	N
Methylene Chlorobromide	N
Methylene Iodine	N
Methylsulfuric Acid	R
Milk	R
Mineral Oil	R
Molasses	R
Monochloroacetic Acid	R
Monochlorobenzene	N
Monothanolamine	R
Monosodium Glutamate	R
Motor Oil	R
Morpholine	R
N	
Naphtha	R
Naphthalene	C
Natural Gas	R
Neutral Red	R
Nickel Acetate	R
Nickel Ammonium Sulfate	---
Nickel Chloride	R
Nickel Nitrate	R
Nickel Sulfate	R
Nicotine	R
Nicotinic Acid	R
Nitric Acid 10%	R
Nitric Acid 30%	R
Nitric Acid 40%	R
Nitric Acid 50%	R
Nitric Acid 70%	R
Nitric Acid 100%	R
Nitrobenzene	N
Nitroethane	C
Nitrogen Gas	---
Nitroglycerine	C
Nitroglycol	---
Nitromethane	C
Nitrous Acid	R
Nitrous Oxide	R
O	
n-Octane	C
Octanol	R
Oleic Acid	R
Oleum	R
Olive Oil	C
Orange G - acid orange 10	R

CHEMICAL	RATING
Orange IV - acid orange 5	R
Orcinol	R
Osmium Tetroxide	R
Oxalic Acid	R
Oxygen Gas	R
Ozone	R
Ozonized Water	R
P	
Palm Oil	R
Palmitic Acid 10%	R
Palmitic Acid 70%	R
Pancreatin	R
Papain	R
Paraffin	R
Peanut Oil	C
Pectin	R
n-Pentane	C
Pepsin	R
Peracetic Acid	R
Perchloric Acid 15%	R
Perchloric Acid 70%	R
Perchloroethylene	C
Periodic Acid	R
Perphosphate	R
Phenol	R
Phenolphthalein	R
Phenyl Salicylate	R
Phenylhydrazine	C
Phosphate Esters	---
Phosphoric Acid 10%	R
Phosphoric Acid 50%	R
Phosphoric Acid 85%	R
Phosphoric Anhydride	R
Phosphorous (Red)	C
Phosphorous (Yellow)	C
Phosphorous Pentoxide	R
Phosphorous Trichloride	R
Photographic Solutions	R
Phthalic Acid	R
Picric Acid	R
Pine Oil	C
Plating Solutions Brass	R
Plating Solutions Cadmium	R
Plating Solutions Chrome	R
Plating Solutions Copper	R
Plating Solutions Gold	R
Plating Solutions Lead	R
Plating Solutions Nickel	R
Plating Solutions Rhodium	R
Plating Solutions Silver	R
Plating Solutions Tin	R
Plating Solutions Zinc	R
Polyvinyl Acetate	---
Polyvinyl Alcohol	R
Potash	R
Potassium Acetate	R
Potassium Alum	R
Potassium Aluminum	R
Potassium Bicarbonate	R
Potassium Bichromate	R
Potassium Bisulfate	R
Potassium Bitartrate	R
Potassium Borate	R
Potassium Bromate	R
Potassium Bromide	R
Potassium Carbonate	R
Potassium Chlorate	R
Potassium Chloride	R
Potassium Chromate	R
Potassium Citrate	R
Potassium Cyanide	R
Potassium Dichromate	R
Potassium Ethyl Xanthate	---
Potassium Ferricyanide	R
Potassium Ferrocyanide	R
Potassium Fluoride	R
Potassium Hydrogen Phosphate	R
Potassium Hydrogen Phthalate	R
Potassium Hydroxide	R
Potassium Hypochlorite	R
Potassium Iodate	R
Potassium Iodide	R
Potassium Nitrate	R

CHEMICAL	RATING
Potassium Nitrite	R
Potassium Perborate	R
Potassium Perchlorate	R
Potassium Permanganate 10%	R
Potassium Permanganate 25%	R
Potassium Persulfate	R
Potassium Phosphate	R
Potassium Sodium Tartrate	R
Potassium Sulfate	R
Potassium Sulfide	R
Potassium Sulfite	R
Potassium Thiocyanate	R
Propane	R
Propargyl Alcohol	R
Propionic Acid	R
Propyl Acetate	---
Propyl Alcohol	R
N-Propyl Bromide	---
Propylene Dichloride	N
Propylene Glycol	R
Propylene Oxide	R
Pyridine	R
Pyrogalllic Acid	R
Pyrrrole	R
Q	
Quinine Sulfate	R
Quinine Chloride Dihydrate	R
Quinone	---
R	
Rayon Coagulating Bath	R
Rennin	R
Resazurin	R
Ringers Solution	R
Rose Bengal Acid Red 94	R
S	
Safranin O	R
Salicylaldehyde	N
Salicylic Acid	R
Selenic Acid, Aq.	R
Silicic Acid	R
Silicone Oil	R
Silver Acetate	R
Silver Chloride	R
Silver Cyanide	R
Silver Nitrate	R
Silver Sulfate	R
Soaps	R
Sodium Acetate	R
Sodium Alum	R
Sodium Aluminate	R
Sodium Arsenate	R
Sodium Benzoate	R
Sodium Bicarbonate	R
Sodium Bichromate	R
Sodium Bisulfate	R
Sodium Bisulfite	R
Sodium Borate	R
Sodium Bromide	R
Sodium Carbonate	R
Sodium Chlorate	R
Sodium Chloride	R
Sodium Chlorite	R
Sodium Chromate	R
Sodium Citrate	R
Sodium Cyanide	R
Sodium Dichromate	R
Sodium Diphenylamine Sulfonate	R
Sodium Dithionite	R
Sodium Ferricyanide	R
Sodium Ferrocyanide	R
Sodium Fluoride	R
Sodium Hexametaphosphate	R
Sodium Hydroxide 15%	R
Sodium Hydroxide 30%	R
Sodium Hydroxide 50%	R
Sodium Hydroxide 70%	R
Sodium Hypochlorite	R
Sodium Iodate	R
Sodium Iodide	R
Sodium Metabisulfite	R

LabWaste™ CPVC Technical Information & Installation Guide



CHEMICAL	RATING
Sodium Metaphosphate	R
Sodium Nitrate	R
Sodium Nitrite	R
Sodium Palmirate	R
Sodium Perborate	R
Sodium Perchlorate	R
Sodium Periodate	R
Sodium Peroxide	R
Sodium Phosphate Acid	R
Sodium Phosphate Alkaline	R
Sodium Phosphate Neutral	R
Sodium Propionate	R
Sodium Silicate	R
Sodium Sulfate	R
Sodium Sulfide	R
Sodium Sulfite	R
Sodium Thiou sulphate	R
Sour Crude Oil	R
Soybean Oil	C
Stannic Chloride	R
Stannous Chloride	R
Stannous Sulfate	R
Starch	R
Stearic Acid	R
Streptomycin Sulfate	R
Strontium Bromide	R
Strontium Chloride	R
Styrene	N
Succinic Acid	R
Sugar	R
Sulfamic Acid	R
Sulfate Liquors	R
Sulfite Liquors	R
Sulfur	R
Sulfur Chloride	R
Sulfur Dioxide Gas Dry	R
Sulfur Dioxide Gas Wet	R
Sulfur Trioxide Gas Dry	---
Sulfur Trioxide Gas Wet	N
Sulfuric Acid Up to 30%	R
Sulfuric Acid 50%	R
Sulfuric Acid 60%	R
Sulfuric Acid 70%	R
Sulfuric Acid 80%	R
Sulfuric Acid 90%	R
Sulfuric Acid 93%	R
Sulfuric Acid 94%	R
Sulfuric Acid 95%	R
Sulfuric Acid 96%	R
Sulfuric Acid 98%	R
Sulfuric Acid 100%	R
Sulfurous Acid	R

T

Tall Oil	R
Tannic Acid	R
Tanning Liquors	R
Tar	C
Tartaric Acid	R
Terpineol	---
Tetrachloroethane	N
Tetrachloroethylene	N
Tetracycline hydrochloride	
Tetraethyl Lead	R
Tetrahydrofuran	R
Tetralin	N
Thiamine Hydrochloride	R
Thionin	R
Thionyl Chloride	R
Thymol	R
Titanium Dioxide	R
Titanium Tetrachloride	R
Toluene	C
Tomato Juice	R
Transformer Oil	R
Transformer Oil DTE/30	R
Tributyl Citrate	---
Tributyl Phosphate	R
Trichloroacetic Acid	R
Trichloroethylene	N
Triethanolamine	R
Triethylamine	R
Trimethylpropane	R
Trisodium Phosphate	R
Trypsin	R
Tung Oil	C
Turpentine	C

CHEMICAL	RATING
U	
Urea	R
Urease	R
Urine	R
V	
Varnish	---
Vaseline	C
Vegetable Oil	C
Vinegar	R
Vinyl Acetate	R
W	
Water, Acid Mine	R
Water, Deionized	R
Water, Distilled	R
Water, Potable	R
Water, Salt	R
Water, Sea	R
Water, Soft	R
Water, Waste	R
Whiskey	R
White Liquor	R
Wine	R
X	
Xylene	C
Z	
Zinc Acetate	R
Zinc Carbonate	R
Zinc Chloride	R
Zinc Nitrate	R
Zinc Stearate	R
Zinc Sulfate	R

SPEARS® MANUFACTURING COMPANY

PRODUCT LIMITED LIFETIME WARRANTY

Except as otherwise specified for certain products, mandated by law or herein provided, Spears® Manufacturing Company ("Company") warrants Standard Catalog Products ("Products") which have been directly manufactured by them to be free from defects in material and workmanship for as long as the original intended end user of the Products ("End User") retains ownership and possession of the Products and complies with this Warranty ("Warranty Period"). Each other person or entity acquiring or employing the Products, including buyers, contractors and installers ("Buyer") and End Users ("Buyer/End User") agrees that this Warranty shall be effective only during the Warranty Period so long as the Products are used solely for the normal purposes for which they are intended and in conformance with industry established standards, engineering, installation, operating, and maintenance specifications, recommendations and instructions including explicit instructions by the Company; the Products are properly installed, operated and used, and have not been modified; and all the other terms of this Warranty are complied with. Any violation thereof shall void this Warranty and relieve Company from all obligations arising from this Warranty and the Products.

Upon receipt or discovery of any Products that appear questionable or defective each Buyer/End User shall promptly inspect and return any such Product to the Company at 15853 Olden Street, Sylmar, California 91342, accompanied by a letter stating the nature of any problems. If the Products are determined by Company to be defective in materials or workmanship directly provided by Company, Company, at its sole option, may either repair or replace the defective Products, or reimburse applicable Buyer/End User for the cost of such Products. The applicable Buyer/End User shall bear all applicable shipping costs. **THIS SHALL BE BUYERS/END USERS' SOLE REMEDY. EACH BUYER/END USER AGREES THAT COMPANY WILL NOT BE RESPONSIBLE FOR ANY OTHER OBLIGATIONS RELATING TO THE PRODUCTS, INCLUDING ANY OTHER MATERIALS OR LABOR COSTS, LOSS OF USE OR ANY OTHER ITEM OR FOR ANY DELAYS IN COMPLYING WITH THIS WARRANTY BEYOND COMPANY'S REASONABLE CONTROL.**

COMPANY SHALL NOT BE LIABLE FOR, DOES NOT ASSUME, AND EXPRESSLY DISCLAIMS, ANY LIABILITY, RESPONSIBILITY AND DAMAGES: DUE TO ANY BUYER/END USER'S FAILURE TO COMPLY WITH THIS WARRANTY, INCLUDING IMPROPER INSTALLATION, USE OR OPERATION; USE WITH PRODUCTS FROM OTHER MANUFACTURERS THAT DO NOT MEET ASTM OR OTHER APPLICABLE PRODUCT STANDARDS; IMPROPER CONTROL OF SYSTEM HYDRAULICS, IMPROPER WINTERIZATION PROCEDURES, IMPROPER VOLTAGE SUPPLY, CONTACT WITH INCOMPATIBLE MATERIALS OR CHEMICALS, EXCAVATION/DIGGING, EXCESSIVE WEIGHT, AND VANDALISM; DUE TO REASONABLE WEAR AND TEAR AND DUE TO ANY ACTS OF NATURE, INCLUDING LIGHTNING, EARTHQUAKES, GROUND MOVEMENT, FROST HEAVE, OR FLOODS.

COMPANY EXTENDS ONLY THIS WARRANTY AND EXPLICITLY DISCLAIMS ALL OTHER WARRANTIES, WHETHER IMPLIED OR OTHERWISE EXPRESSED, WHETHER ORAL, STATUTORY OR OTHERWISE, INCLUDING ANY IMPLIED WARRANTIES OR AFFIRMATIONS FOR SUITABILITY, MERCHANTABILITY OR FITNESS FOR A PARTICULAR PURPOSE. NO AFFIRMATION BY COMPANY OR ANY OF ITS REPRESENTATIVES, BY WORDS, CONDUCT OR OTHERWISE, SHALL CONSTITUTE A WARRANTY. THIS WARRANTY MAY NOT BE TRANSFERRED, EXTENDED, ALTERED OR OTHERWISE MODIFIED IN ANY MANNER, EXCEPT BY WRITTEN AGREEMENT SIGNED BY COMPANY.

BY ITS ACCEPTANCE OF THE PRODUCTS, EACH BUYER/END USER EXPRESSLY WAIVES ALL OTHER LIABILITY OR OBLIGATION OF ANY KIND OR CHARACTER OF COMPANY, INCLUDING LIABILITY PREDICATED UPON CONTRACT, TORT, STRICT LIABILITY OR OTHER LEGAL OR EQUITABLE GROUNDS, AND ALL, IF ANY, DAMAGES AND LOSSES AS A RESULT THEREOF, INCLUDING ALL, IF ANY, COMPENSATORY, GENERAL, SPECIAL, CONSEQUENTIAL, INCIDENTAL, OR PUNITIVE DAMAGES, WITH RESPECT TO SUCH WAIVERS, EACH BUYER/END USER EXPLICITLY WAIVES CALIFORNIA CIVIL CODE §1542 WHICH STATES "A GENERAL RELEASE DOES NOT EXTEND TO CLAIMS WHICH THE CREDITOR DOES NOT KNOW OR SUSPECT TO EXIST IN HIS FAVOR AT THE TIME OF EXECUTING THIS RELEASE, WHICH IF KNOWN BY HIM MUST HAVE MATERIALLY ADVERSELY AFFECTED HIS SETTLEMENT WITH DEBTOR" AND ALL OTHER SIMILAR STATUTORY, COMMON AND CASE LAW RIGHTS, DEFENSES AND LIMITATIONS.

Having previously independently inspected the Products, or a sample, as fully as desired, or having the opportunity to and having not done so, upon acceptance of delivery of the Products, and except as otherwise herein explicitly provided, each Buyer/End User by acceptance or use of the Products accepts them in their "AS IS" and "WITH ALL FAULTS" condition without any other warranty, expressed, implied or otherwise, and accepts and assumes the entire risk and cost of all servicing, remediation and consequences thereof. This Warranty shall be governed by California law and any unenforceable provisions severed without affecting the remaining provisions. As used herein, "including" includes "without limitation."



SPEARS® MANUFACTURING COMPANY

Corporate Office

15853 Olden Street • Sylmar, CA 91342

PO Box 9203 • Sylmar, CA 91392

(818) 364-1611 • <http://www.spearsmfg.com>

